

SPECTROPHOTOMETER CM-25cG

Instruction Manual



Please read before using the instrument.



KONICA MINOLTA



■ Notification for California Customers

Perchlorate Material - Special handling may apply,
see www.dtsc.ca.gov/hazardouswaste/perchlorate.

Official names for applications and the like used in this manual

(Wording used in text)	(Official name)
Bluetooth	Bluetooth®

Trademarks

- The Bluetooth® mark and logo are registered trademarks of The Bluetooth SIG, Inc. and are used under license.
- The KONICA MINOLTA logo and symbol marks and SpectraMagic are registered trademarks of Konica Minolta, Inc.

■ Safety Symbols

The following symbols are used in this manual and on the product to prevent accidents that may occur because of incorrect use of the instrument.



**Denotes an instruction regarding a safety warning or note.
Read the instruction carefully to ensure safe and correct use.**



**Denotes an instruction regarding the risk of electric shock.
Read the instruction carefully to ensure safe and correct use.**



**Denotes an instruction regarding the risk of fire.
Read the instruction carefully to ensure safe and correct use.**



**Denotes a prohibited operation.
This operation must never be performed.**



**Denotes an instruction.
This instruction must be strictly adhered to.**



**Denotes an instruction.
Be sure to disconnect the plug from the outlet.**



**Denotes a prohibited operation.
Never disassemble the instrument.**



This symbol indicates alternating current (AC).



This symbol indicates direct current (DC).



This symbol indicates class II protection against electric shock.





■ Notes on this Manual









- Copying or reproduction of all or part of the contents of this manual without the permission of KONICA MINOLTA is strictly prohibited.
- The contents of this manual are subject to change without prior notice.
- The latest instruction manual can be downloaded from the following URL:
http://www.konicaminolta.com/instruments/download/instruction_manual/index.html
- Every effort has been made in the preparation of this manual to ensure the accuracy of its contents. However, should you have any questions or find any errors, please contact your retailer or a **KONICA MINOLTA-authorized service facility**.
- KONICA MINOLTA will not accept any responsibility for consequences arising from the use of the instrument.

Safety Precautions

To ensure correct use of this instrument, read the following points carefully and adhere to them. After you have read this manual, keep it in a safe place where it can be referred to anytime a question arises.

	WARNING (Failure to adhere to the following points may result in death or serious injury.)
	Do not use the instrument in places where flammable or combustible gases (gasoline, etc.) are present. Doing so may cause a fire.
	Always use the AC adapter supplied as a standard accessory or the optional AC adapter (AC-A305J)/L/M), and connect it to a 100-240 VAC (50/60 Hz) AC outlet of the rated voltage and frequency. If an AC adapter other than those specified by KONICA MINOLTA is used, or if the adapter is connected to an unsupported voltage, it may result in damage to the adapter, fire, or electric shock.
	If the instrument will not be used for a long time, disconnect the AC adapter power plug from the AC outlet. Accumulated dirt or water on the prongs of the AC adapter's plug may cause a fire and should be removed. Clean off any dirt or water on the prongs of the AC adapter's plug before use.
	Firmly push the AC adapter power plug completely into the outlet. Incomplete insertion may cause fire or electric shock.
	Do not forcibly bend, twist, or pull the cords or cables. Also, do not scratch, or place heavy objects on the cables. Doing so may damage the cable and cause a fire or electric shock.
	Do not disassemble or modify the instrument or the AC adapter. Doing so may cause a fire or electric shock.
	Take special care not to allow liquid or metal objects to enter the instrument and the AC adapter. Doing so may cause a fire or electric shock. Should liquid or metal objects enter the instrument, turn the power OFF immediately, disconnect the AC adapter power plug from the AC outlet, remove the battery, and contact the nearest KONICA MINOLTA-authorized service facility .
	Do not dispose of the battery in a fire, short-circuit, heat, or disassemble the battery. Doing so may cause the battery to rupture or leak, which could result in fire or injury.
	In the event that a battery leaks and the fluid comes into contact with the eyes, do not rub the eye. Wash it with clean water, and then immediately consult a doctor. If the leaked fluid comes into contact with skin or clothing, immediately rinse with water. In addition, stop using the instrument if the battery has leaked.
	When disposing of the battery used in this instrument, use tape or some other material to electrically insulate the contacts. Contact with other metals may cause the battery to overheat, rupture, or catch fire. Properly dispose of the battery according to local regulations or recycle the battery.
	The instrument should not be operated if it or the AC adapter is damaged, or if smoke or odd smells occur. Doing so may cause a fire. In such situations, turn the power OFF immediately, disconnect the AC adapter plug from the AC outlet, remove the battery, and contact the nearest KONICA MINOLTA-authorized service facility .
	Do not look directly at the lamp. The lamp is extremely bright and emits ultraviolet rays. Looking directly at the light may injure the eyes.
	Do not insert or disconnect the AC adapter plug with wet hands. Doing so may cause electric shock.
	Do not touch the battery with wet hands. Doing so may result in electric shock or a malfunction.
	Use the dedicated charger to charge the lithium-ion battery. If charging conditions or a charger different from that specified is used for charging, the battery may leak, overheat, or catch fire.

	Do not use, charge, or store the lithium-ion battery in a high-temperature environment. Doing so may cause the batteries to overheat, catch fire, or rupture.
	Do not throw or submit the lithium-ion battery to strong impacts such as from a fall from a high location. If the lithium-ion battery is deformed or if the built-in protection system is broken, an abnormal current or voltage may be applied to the battery during charging, which may cause the batteries to overheat, rupture, or catch fire.
	Do not step on the lithium-ion battery or pierce with a nail or hit with a hammer. If the lithium-ion battery is deformed or if the protection system is damaged, the battery may overheat, rupture, or catch fire.
	Should an unusual odor, heat, discoloration, deformation, or other previously unnoticed abnormality occur during use, charging, or storage, remove the battery from the instrument or charger and discontinue use. Continued use of a battery in this condition may cause the batteries to overheat, rupture, or catch fire.
	If the lithium-ion battery is found to be leaking or emitting an unusual odor, keep the battery away from any open flames. The electrolytic solution from the battery may catch fire, causing rupture or fire.

	CAUTION (Failure to adhere to the following points may result in injury or damage to the instrument or other property.)
	When using the AC adapter, make sure, that an AC outlet is located near the instrument, and that the AC adapter plug can be connected to and disconnected from the AC outlet easily.
	When cleaning the instrument, unplug the AC adapter plug from the outlet. Failure to do so may result in electric shock.
	Do not use any battery other than that specified for use with the instrument. When inserting a battery into the instrument, be sure to insert the battery correctly according to the polarity (positive +, negative -) display on the instrument. Fire, injury, or stains on surroundings may occur if the battery is damaged or leaking.
	Do not use a wet battery. Doing so may cause the battery to rupture or overheat, which could result in fire or injury.
	Do not place the instrument on an unstable or sloping surface. Doing so may result in the instrument dropping or overturning, causing injury. Be careful not to drop the instrument when carrying it as well.
	Do not use the instrument if the sample specimen measuring port (measurement area) is in the line of sight. Doing so may result in injury to the eye.
	Take care not to pinch yourself on the areas of the instrument that open and close. Doing so may result in injury.

Introduction

The CM-25cG is a 45-degree circumferential illumination / vertical viewing model spectrophotometer capable of measuring both color and gloss in a single measurement.

Packing materials of the product

Be sure to keep all packing materials used for shipping the instrument (cardboard box, cushioning material, plastic bags, etc.). This instrument is a precision measuring instrument. When transporting the instrument to a service facility for maintenance or for other reasons, be sure to use the packing materials to minimize shock or vibration. If the packing materials are lost or damaged, contact a **KONICA MINOLTA-authorized service facility**.

■ Notes on Use

Operating Environment

- The AC adapter supplied as a standard accessory (AC-A305J/L/M) has been designed exclusively for indoor use. Outdoor use is prohibited.
- This instrument is composed of precision electronic components. Never disassemble the instrument.
- Always use the AC adapter supplied as a standard accessory (AC-A305J/L/M) and connect it to a 100-240 VAC (50/60 Hz) AC outlet. Use an AC power supply of the rated voltage (within $\pm 10\%$).
- This instrument is a pollution level 2 product (equipment to be used primarily in manufacturing environments, laboratories, warehouses, and similar locations). This instrument should be used in environments where exposure to metallic dust or condensation is not a concern.
- This instrument is an overvoltage category I product (equipment for connection to circuits in which measures are taken to limit transient overvoltage to an appropriately low level).
- Take care to prevent foreign matter from entering the instrument. Using the instrument while subjected to intrusion of water or metals is extremely dangerous.
- Using the instrument in direct sunlight or near heating equipment can cause the internal temperature of the instrument to become much higher than the ambient temperature, resulting in malfunction. Do not use the instrument in such areas.
- Avoid subjecting the instrument to sudden temperature changes and condensation.
- Do not use the instrument in areas where dust, smoke, or chemical gases are present, or in extremely humid environments.
- This instrument should be used in an environment with an ambient temperature between 5°C and 40°C and a relative humidity of 80% or less (at 35°C) with no condensation. Use of the instrument outside this range will result in unsatisfactory performance.
- Do not use the instrument at altitudes higher than 2,000 m.
- Do not use the instrument near equipment that produces a strong magnetic field (such as speakers).
- To secure the instrument for use, make sure the instrument is firmly attached with no possibility of falling off. Failure to do so may result in harm to the instrument or people and objects around the instrument.

System

- Do not subject the instrument to strong vibrations or impacts.
- Do not pull, forcibly bend, or apply excessive force to the connected cables and cords. Doing so may cause the cable or cord to break.
- Do not allow the specimen measuring port of the instrument to become dirty or subject the aperture to impact. Place the instrument on the calibration stage (CM-A217) when not in use.
- This instrument and the AC adapter are EMC Class B products. Use of the instrument and the AC adapter in home environments may cause radio interference. Users may be required to take appropriate measures in such cases.
- If the instrument is exposed to strong external static electricity, the LCD may go blank or fail to display information correctly. Communication with a connected external device may also be interrupted. In such cases, turn the power OFF and then ON again. If black smudges appear on the LCD, wait until they disappear naturally.

- When turning the power OFF and then ON again, wait several seconds after turning the power OFF before turning the power ON again.
- The instrument should be connected to a power source with as little noise as possible.
- When a malfunction or abnormal behavior occurs, turn the power OFF immediately, disconnect the AC adapter plug from the AC outlet, and refer to “Troubleshooting” on page 131.
- Should the instrument break down, do not try to disassemble and repair the instrument. Contact a **KONICA MINOLTA-authorized service facility**.

Backup Battery

- Various settings are stored in the instrument’s built-in battery-powered backup memory. The backup battery will be charged when the instrument is powered or when the lithium-ion battery is being charged, regardless of whether the power switch is turned ON/OFF. The backup battery takes 20 hours to become fully charged, and there is no danger of overcharging. At full charge, the backup battery can store data for up to one year. However, the backup battery may not be fully charged when the instrument is purchased. The backup battery will charge as the instrument is being used.
- Do not attempt to replace the built-in backup battery. The battery should only be replaced by KONICA MINOLTA. To replace the backup battery, please contact a **KONICA MINOLTA-authorized service facility**.
- It is recommended to manage important data using the optional SpectraMagic DX software.

Calibration Plate

- The calibration data for the calibration plate was measured at 23°C. To achieve the highest accuracy when measuring absolute values, calibration and measurement should be performed at 23°C.
- Do not allow the calibration plate to become scratched or dirty.
- When the calibration plate is not in use, be sure to close the cap so that the plate is not exposed to light.

Power Source

- Make sure that the power is turned OFF when the instrument is not in use.
- This instrument should be used with the lithium-ion battery installed. You cannot use the instrument connected to the AC adapter only.
- Make sure the AC adapter output plug is not short-circuited. Doing so may cause a fire or electric shock.
- Do not connect the AC adapter to an overloaded electrical circuit. In addition, do not wrap or cover the AC adapter with cloth or other material while in use. Doing so may cause an electric shock or fire.
- When removing the AC adapter from the instrument, first remove the power cord from the outlet, and then remove the output plug.

Battery

- Use only the standard lithium-ion battery or the optional accessory lithium-ion battery CM-A235 (RRC1120). Absolutely do not use any other type of battery.
- The battery in the instrument will be charged from the power supplied through the USB cable regardless of whether the instrument is turned ON or OFF.
- The battery is not charged upon purchase and must therefore be charged.
- The battery takes about 6 hours to become fully charged. There is no need to worry about overcharging.
- The lithium-ion battery will self-discharge. The battery will become unusable due to over discharging if left for a long period. Charge the battery for at least one hour using the instrument or an optional battery charger at least semiannually.
- After using up the lithium-ion battery, do not leave it uncharged.
- Charging should be performed at between 5 and 40°C. Charging will not be performed outside this temperature range.
- If the lithium-ion battery will not be used for a long period, remove the battery from the instrument and store it in a location not subject to high temperatures or high humidity.

Introduction (Cont.)

■ Notes on Storage

- Storing the instrument in direct sunlight or near heating equipment can cause the internal temperature of the instrument to become much higher than the ambient temperature, resulting in malfunction. Do not store the instrument in such areas.
- This instrument should be stored at a temperature between 0°C and 45°C with a relative humidity of 80% or less (at 35°C) and no condensation. Storing the instrument in an environment with high temperatures and high humidity will result in unsatisfactory performance. Storing the instrument and the drying agent at or near room temperature is recommended.
- Make sure that the instrument is not subjected to condensation when stored. In addition, take care to prevent rapid temperature changes to prevent condensation from occurring when transporting the instrument to the storage location.
- Do not store the instrument in areas where dust, smoke, or chemical gases are present. Doing so may cause deterioration in performance or a malfunction.
- Do not leave the instrument inside the cab or trunk of a vehicle. Otherwise, the temperature and/or humidity during midsummer or midwinter may exceed the allowable range for storage, resulting in a malfunction.
- Dust inside the specimen measuring port may prevent accurate measurements from being performed. When the instrument is not in use, use the lid to prevent the intrusion of dust and the like.
- The calibration plate may become discolored if left exposed to light. Therefore, make sure to close the cap when the plate is not in use in order to prevent the plate from being exposed to light.
- When not in use, store the instrument in the packing used for shipment or in the optional hard case and keep it in a safe place.
- Take care not to pinch yourself on the areas of the protective hard case that open and close. Doing so may cause injury.

■ Notes on Cleaning

- If the instrument becomes dirty, wipe it with a soft, dry cloth. Never use organic solvents (such as benzene or thinner) or other chemicals for cleaning.
- If there is dust or dirt on the lens or the receptor window, use a blower or the like to blow it off. Never use organic solvents (such as benzene or thinner) or other chemicals for cleaning.
- If the calibration plate becomes dirty, gently wipe the dirt off using the supplied cleaning cloth. If the dirt is excessive, wipe with a cleaning cloth slightly moistened with ethyl alcohol. If the cleaning cloth is dirty, clean the cloth by washing it.
- If you are unable to remove dirt from the instrument through the above procedure, or if the instrument becomes scratched, contact a **KONICA MINOLTA-authorized service facility**.
- If you are unable to remove dirt from the instrument or if the instrument becomes scratched, contact a **KONICA MINOLTA-authorized service facility**.

■ Notes on Transporting

- When transporting the instrument, be sure to use the packing materials to minimize shock or vibration.
- When sending the instrument in for service, package and send the instrument and all accessories.

■ Maintenance and Inspection

- To maintain measurement accuracy, the instrument should be inspected once a year. For information on inspection, contact the nearest **KONICA MINOLTA-authorized service facility**.



■ Disposal Method

- Make sure that the instrument, all accessories (including any used batteries), and the packing materials are either disposed of or recycled correctly in accordance with local laws and regulations.
- In the United States and Canada, you can recycle your lithium-ion battery through the Call2Recycle program. For more information, in the United States visit www.call2recycle.org and in Canada visit www.call2recycle.ca.



Table of Contents

■ Notification for California Customers.....	i	Calibration	32
■ Safety Symbols	ii	■ Zero Calibration	32
■ Notes on this Manual	ii	■ White Calibration and Gloss Calibration	34
Introduction	3	■ User Calibration	36
■ Notes on Use.....	3	Setting a Specimen.....	37
■ Notes on Storage	5	■ Viewfinder	37
■ Notes on Cleaning.....	5	Measurement.....	38
■ Notes on Transporting.....	5	■ Measurement/Data Display Screen.....	39
■ Maintenance and Inspection	5	■ Measurement (Simple Mode).....	42
■ Disposal Method.....	6	Handling the Sample	44
■ Conventions	9	■ Print	45
□ Instrument Firmware Version	9	■ Edit Name.....	46
Chapter 1 Before Using the Instrument.. 10		■ Sample Data Management.....	47
Accessories	11	□ Delete.....	47
■ Standard Accessories.....	11	□ Set Sample as Target	48
■ Optional Accessories.....	12	□ Change Target Reference	49
System Diagram	14	□ Change List Position.....	50
Names and Functions of Parts.....	15	□ Delete All Data	51
□ Calibration Stage CM-A217	17	■ Auto Target (Sample)	52
■ Cleaning Parts.....	18	□ Auto Target (Sample).....	52
□ Zero Calibration Hole (Calibration Stage)...	18	□ Threshold (Sample).....	53
□ White Calibration / Gloss Calibration Plate (Standard Accessories).....	18	Pass/Fail Judgment for Color Difference.....	54
Points to Remember	19	■ Pass/Fail Judgment Based on Tolerances.....	54
■ Initial Settings.....	19	Color Difference Target Color Operation	56
■ Control Panel	19	■ Print	57
□ Display (LCD Screen).....	19	■ Edit Name.....	58
□ Status Bar	20	■ Target Data Management.....	59
□ Control Keys.....	21	□ Delete.....	59
□ Changing Screens	22	□ Set Group.....	60
■ Menus	23	□ Change List Position.....	61
■ Data Saving	25	□ Edit Target Filter	62
Chapter 2 Measurement..... 26		□ Data Protection	63
Flow of Measurement	27	□ Delete All Data	64
Preparation	28	■ Pass/Fail.....	65
□ Attaching the Wrist Strap	28	□ Tolerance Settings.....	66
□ Inserting the Battery	29	□ Tolerance List	67
□ Connecting the AC Adapter	30	□ Warning Level Setting	68
□ Turning the Power ON/OFF	30	□ Parametric Coefficient Setting	69
□ Measurement Area Selection.....	31	■ Input Colorimetric Data.....	70
		□ Color space	70
		□ Input Data.....	71
		■ Default Data Settings	73
		□ Tolerance List	74
		□ Default Tolerance Setting	75

- Warning Level Setting 76
- Parametric Coefficient Setting 77
- Set Group..... 78

Chapter 3 Setup 80

Measurement Condition Settings 81

- Measurement Condition Settings 81
 - Measurement Mode 82
- Measurement Option Settings 83
 - Auto Average (1 to 10)..... 84
 - Manual Average (1 to 30)..... 85
 - SMC Function (Outlier-Free Measurement)... 86
 - SMC Threshold..... 87
 - SMC Times 88
- Display Condition Settings 89
 - Observer/Illuminant 1 90
 - Observer/Illuminant 2 92

- Display Settings 93
 - Display Type..... 94
 - Color Space..... 95
 - Equation 96
 - Custom 97

Instrument Settings..... 98

- Measurement Instrument Option Settings 98
 - User Type 99
 - Display Language Settings 100
 - Setting the Date Format 101
 - Setting the Clock..... 102
 - Screen Brightness 103
 - LCD Screen Display Orientation..... 104
 - Buzzer..... 105
 - Auto Power Off..... 106
 - Password Setting 107

Chapter 4 Other Functions..... 108

Connecting to an External Device 109

◆ Connecting to a Personal Computer 109

- Connecting via USB Cable 110
- Connecting via Bluetooth..... 111
 - Instrument Preparation 111
 - Connecting the Bluetooth Module..... 111
- Communication Setup 112
 - Turning Bluetooth ON 112
 - PC Connection 114

◆ Connecting to a Printer/Barcode Reader .. 115

- Printer/Barcode Reader Preparation 115

○ Instrument Preparation..... 116

- Registering a Bluetooth Address 116
- PIN Code Configuration..... 117
- Printing Data..... 118
- Auto Print..... 119

System Settings..... 121

- Calibration Setup 121
 - Calibration Interval Messages..... 122
 - Annual Calibration Messages 123
 - User Calibration 124
- Displaying Diagnosis Information 125
- Displaying the Instrument Information..... 126
- JOB Function..... 127

Chapter 5 Troubleshooting 128

Message List..... 129

Troubleshooting 131

Chapter 6 Appendix 132

Specifications..... 133

Dimensions 135

Conventions

This manual describes how to safely operate the CM-25cG using a specific procedure to perform measurement.

• Viewing Pages

Symbols used in this manual are explained below.

* Explanatory pages are constructed as follows. (The content of the explanatory illustration will differ from the actual page.)

* Display screenshots used in the explanations may include different content and values, and may have a different layout than the actual display.

Procedure
Indicates an operating procedure.

Settings
Describes ranges and provides explanations regarding settings for the screen in question.

Memo
Provides useful information, supplementary explanations, and similar details.

Notes
Provides essential information for correct operation of the instrument. Always read this information before operating the instrument.

Display Type

Configure the display type for the measurement results.

Memo All display types are selected when the instrument is shipped from the factory.

Operating Procedure Start the procedure from the <Measurement cond.> -> <Display cond.> screen.

1 Use [▲] or [▼] to move the cursor to "Display type", and then press the [Confirmation] key. The <Display type> screen is displayed.

2 Use [▲] or [▼] to move the cursor to the desired display type, and then press the [Confirmation] key.

Selections

- Absolute value: Displays the absolute value of the colorimetric and the gloss value.
- Difference: Displays the color difference and gloss value difference against the target color. The measurement that failed the pass/fail judgment based on the tolerance will be highlighted in red.
- Abs. & Diff.: Displays the absolute value and the color difference and gloss value difference against the target color. The measurement that failed the pass/fail judgment based on the tolerance will be highlighted in red.
- Pass/Fail: Determines whether the color difference and gloss value difference related to the target are within the tolerance range set in advance. If within the tolerance, the judgment will be displayed as "Pass". If even one difference is not within the tolerance, the judgment will be displayed as "Fail".
- Custom: Displays the display color value and index set under "Custom" as the two illuminants.
- Abs. Graph: Displays a graph of the absolute value of the colorimetric and the gloss value.
- Diff. Graph: Displays a graph showing the color difference and gloss value difference against the target color.
- Spectral Graph: Displays a graph showing the spectral reflectance. The [Confirmation] key can be used to move the wavelength displaying the spectral reflectance value.

Memo A check mark means the item is selected.

3 After all settings have been configured, use [▲] or [▼] to move the cursor to "OK", and then press the [Confirmation] key. The selection is confirmed and the screen returns to the previous screen.

Notes If [ESC] is pressed without pressing the [Confirmation] key, the settings will not be changed and the screen will return to the <Display cond.> screen.



3
Screenshot

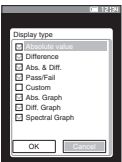

Start screen
Indicates the initial screen from which the operation is commenced.

Screenshot
Indicates the state of the screen when the operation described in the procedure to the left is carried out.

94

Instrument Firmware Version

The version of the instrument firmware can be confirmed on the <Instrument info.> screen. For details, refer to page 126 "Displaying the Instrument Information" in this manual.

Chapter 1

Before Using the Instrument

Accessories	11
Standard Accessories	11
Optional Accessories	12
System Diagram	14
Names and Functions of Parts	15
Cleaning Parts	18
Points to Remember	19
Initial Settings	19
Control Panel.....	19
Menus	23
Data Saving	25

Accessories

Standard and optional accessories are available with the instrument.

Memo The shape of some products may be different from those shown.
*Not available in all areas.

■ Standard Accessories

AC Adapter AC-A305J/L/M (UBX305)*

Used to supply power from an AC outlet to the instrument.

Input: 100 to 240 V \sim 50/60 Hz 0.15 A

Output: 5 V $\overline{\text{---}}$ 1 A

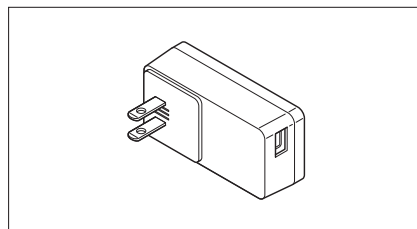

Lithium-ion Battery CM-A235 (RRC1120)*

- Insert the battery into the machine, and connect the instrument to the AC adapter or to a PC using the IF-A26 USB cable to charge.
- The battery itself can also be charged using a separately sold charger.

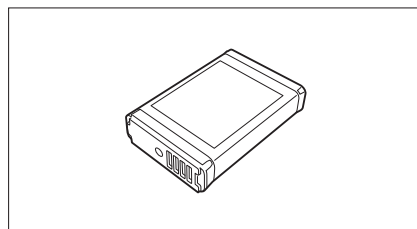

Calibration Stage CM-A217

Used to perform calibration. The set includes the white calibration plate, the zero calibration hole, and a gloss calibration plate.

A data CD with calibration plate calibration data and software for writing calibration values is also included.

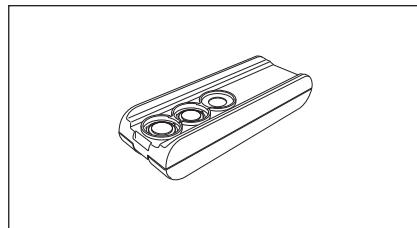

Wrist Strap CR-A73

Used to prevent users from inadvertently dropping the instrument.

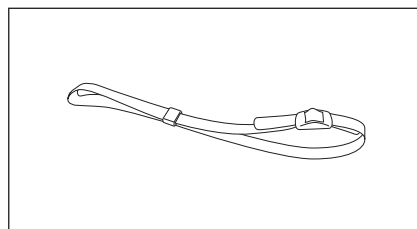

USB Cable (2 m) IF-A26

Used to connect the instrument to a personal computer (PC).

When using the AC adapter, power will be supplied through the cable.

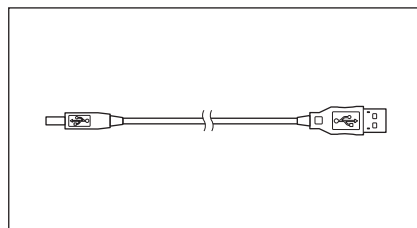

Flat Type Battery Cover CM-A218

Used when the measurement surface of a target specimen is lower than the bottom surface of the instrument.

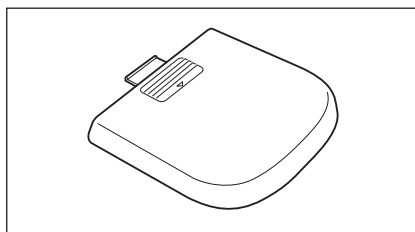
**Cleaning Cloth**

Used to clean the calibration plate.

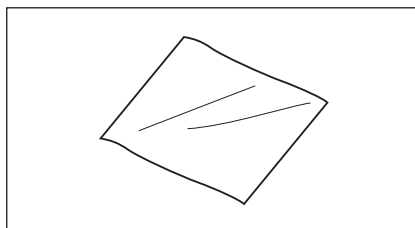
**■ Optional Accessories****Hard Case CM-A236**

Used for carrying the instrument and accessories by hand.

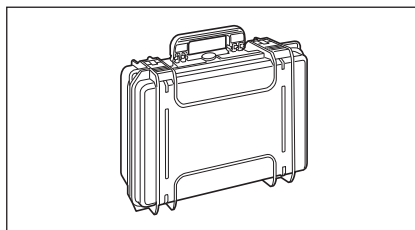
**Replacement Lithium-ion Battery CM-A235 (RRC1120)***

This battery is a replacement for the standard lithium-ion battery.

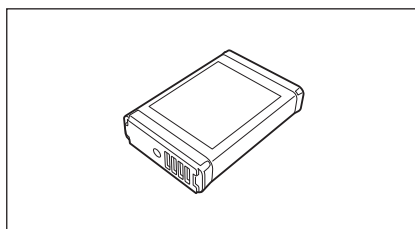
**Bluetooth Module CM-A219***

Used for establishing wireless communication and transferring data between the instrument and a PC or a printer.

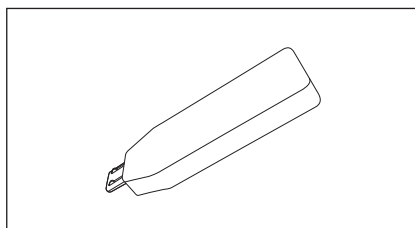
**Bluetooth Printer CM-A234***

Used to print data.

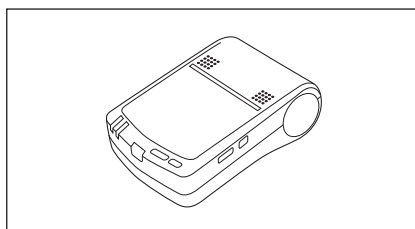

Color Data Software SpectraMagic DX

Used to control the instrument and manage data from a PC.

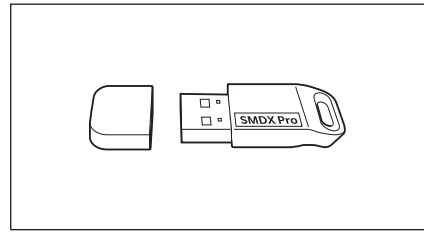

Color Data Software SpectraMagic NX (*Ver. 2.8 or later)

Used to control the instrument and manage data from a PC.

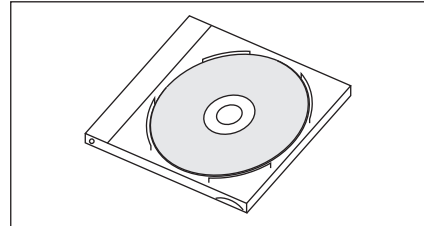

Battery Charger CM-A237 (RRC-SCC1120)*

Used as the dedicated charger to charge the lithium-ion battery. An AC adapter for charging is included.*

Memo Depending on the location, only the cradle (CM-A241) may be available.

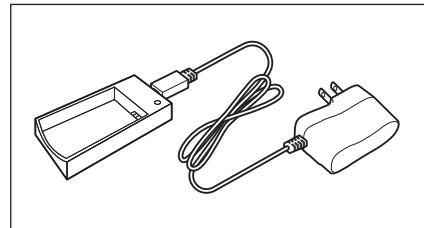

Stapler Type Target Mask CM-A216

Used for easily determining the measurement area when performing color measurements.

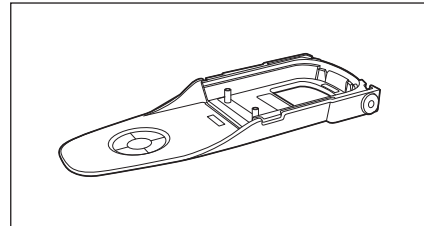

Roll Paper

Used as printing paper for the optional accessory printer.

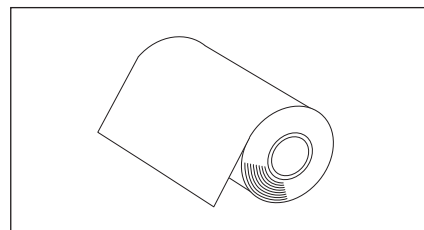

Color Plates (White, black, and 12 other colors)

Used for simple diagnosis of instrument measurement performance (instrumental errors and repeatability).

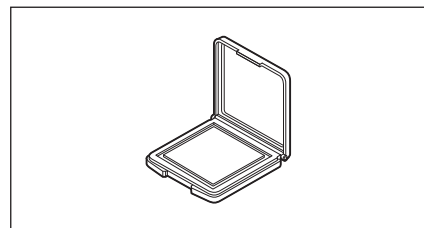

System Diagram

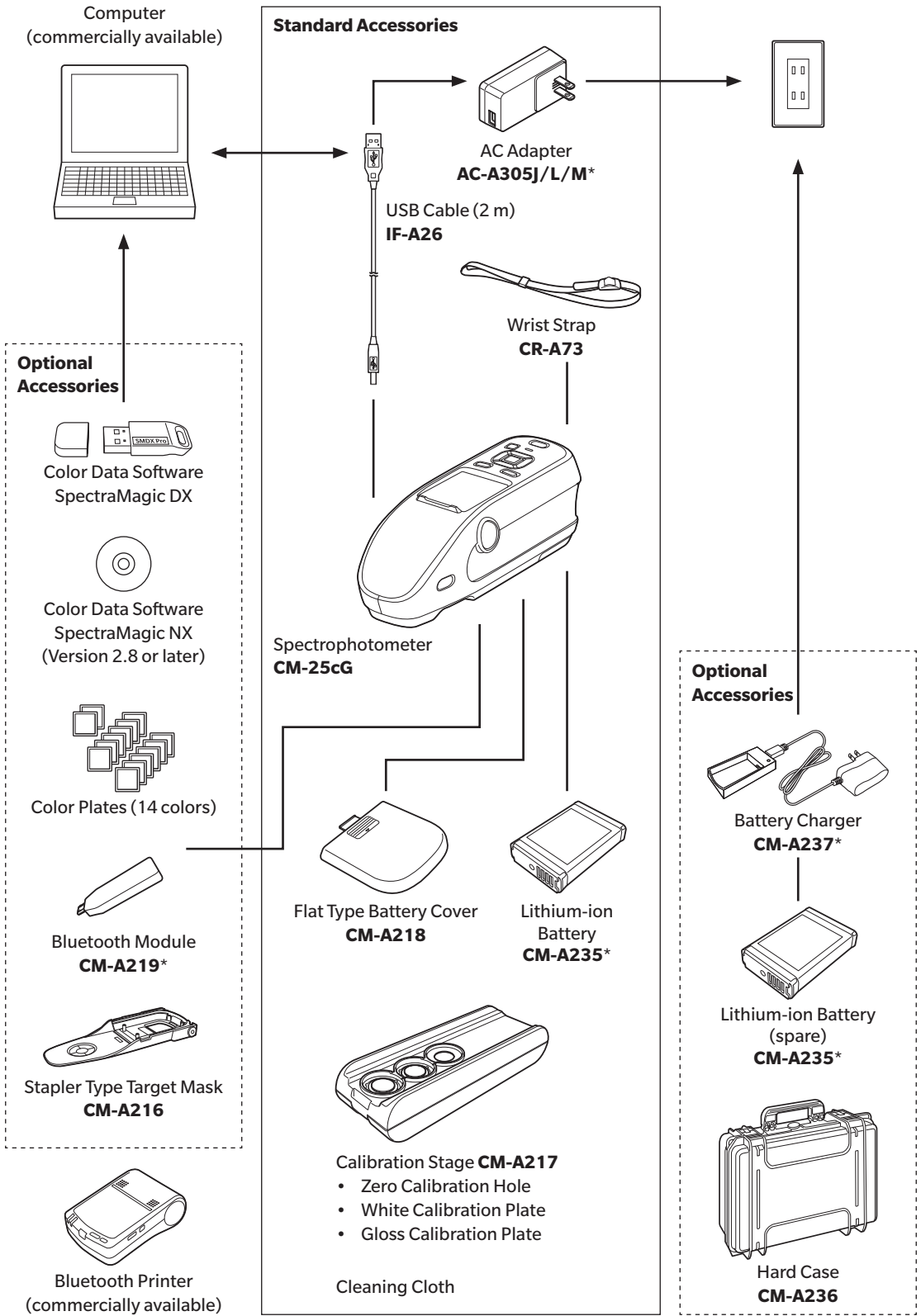

Memo The shape of some products may be different from those shown.
*Not available in all areas.

Names and Functions of Parts

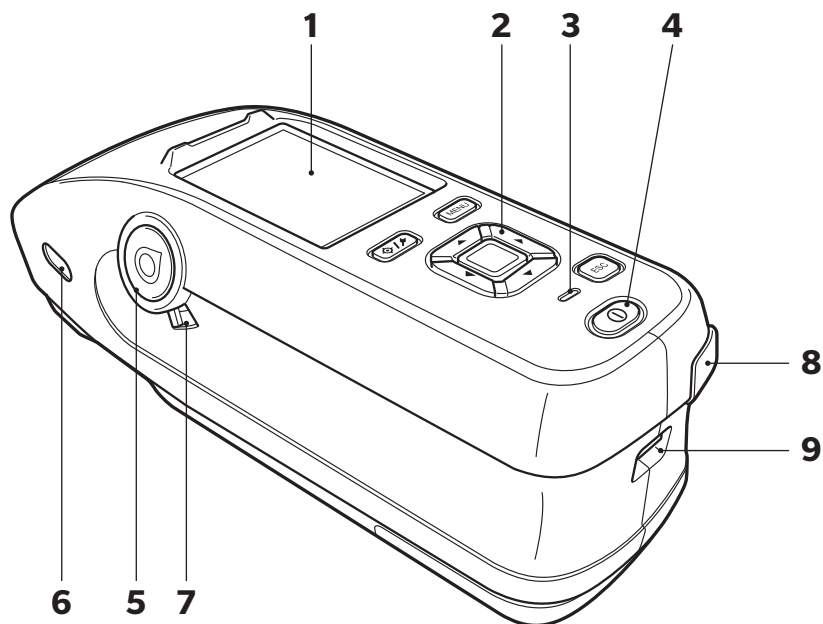

- | | |
|--|--|
| 1 LCD screen | Displays settings, measurement results, messages, etc. |
| 2 Control panel | The keys are used to switch screens and to select, set, or save settings. For details, refer to page 21 “Control Keys”. |
| 3 Charging lamp | Lights up orange when charging via USB power. When charging is complete, the lamp will turn green. |
| 4 Power switch | Used to turn ON/OFF power. The instrument switches between ON/OFF every time the power switch is pressed. |
| 5 Measurement button | Used to perform measurement. A measurement button can be found on both the right and left sides of the instrument. Either button can be used for measurement. |
| 6 Viewfinder
(Specimen confirmation window) | Using the window, users can confirm the measurement location of the specimen. Open the shutter to check the measurement location of the specimen. These windows can be found on both the left and right of the instrument. |
| 7 Viewfinder lever | This lever opens the specimen confirmation window. These windows can be found on both the left and right of the instrument. |
| 8 USB connection terminal
(Micro-B type) | Used to connect the instrument to a PC when using the supplied USB cable (IF-A26). |
| 9 Wrist strap attachment hole | Used to attach the wrist strap. |

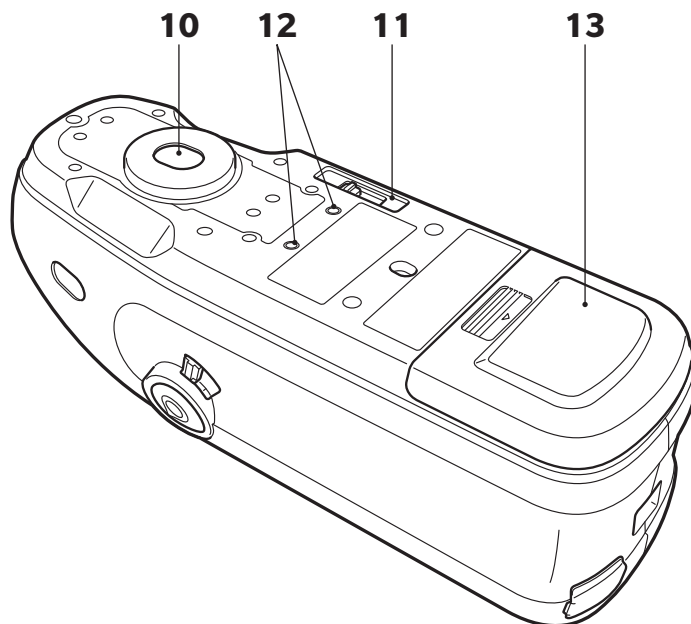

10 Specimen measuring port

This is the aperture for measuring samples.

11 Measurement area switch

Switches the measurement area.

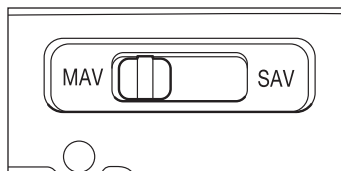

12 Screw holes for securing

Used for mounting the instrument to jigs or other components.

13 Battery compartment cover

Slide this cover to replace the battery or attach the Bluetooth module.

Memo When the measurement surface and the bottom of the instrument are the same height, the standard battery compartment cover should be used. When the measurement surface is lower than the bottom of the instrument, the supplied flat-type cover should be used.

□ Calibration Stage CM-A217

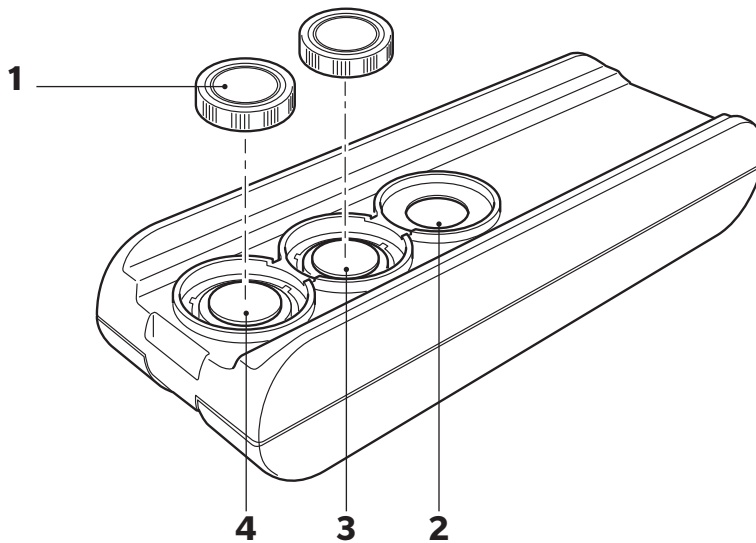

1 Cap

This black cap is used to protect the white calibration plate and gloss calibration plate.

Notes Attach the cap to the white calibration plate and the gloss calibration plate when they are not being used.

2 Zero calibration hole

Used to perform zero calibration.
Make sure no dust gets into the zero calibration hole.

3 White calibration plate

Used to perform white calibration. When the plate is not being used, use the lid to prevent the plate from becoming dusty or scratched and to protect it from external light.

4 Gloss calibration plate

Used to perform gloss calibration. When the plate is not being used, use the lid to prevent the plate from becoming dusty or scratched and to protect it from external light.

■ Cleaning Parts

Zero Calibration Hole (Calibration Stage)

Use a blower to blow off any dust in the zero calibration hole. In addition, cleaning directly with the blower can be performed by removing the cover. In such cases, be careful not to leave behind fingerprints or the like.

White Calibration / Gloss Calibration Plate (Standard Accessories)

- If the white calibration plate or the gloss calibration plate becomes dirty, gently wipe the dirt off using the supplied cleaning cloth.
- If the dirt on the white calibration plate does not come off easily, wipe using a cloth soaked in ethyl alcohol, and then wipe using a cloth soaked in water before drying.
- When a part other than the calibration plate becomes dirty, lightly wipe the dirt off with a cloth dampened with water or soapy water. Never use solvents such as thinner or benzene.

Notes Be careful not to scratch the calibration plate.

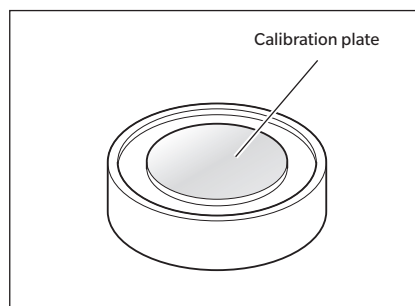

Points to Remember

■ Initial Settings

When first turning the instrument ON after purchasing, the language setting screen will be displayed. Please select the language. The language selection menu can be displayed by turning ON the instrument while holding down **[MENU]**.

The display language can be selected from 11 languages including English. For details, refer to page 98 “Measurement Instrument Option Settings”.

■ Control Panel

The front of the instrument contains the LCD screen, upon which the instrument displays measurement results and messages, and the control keys, which are used to set measurement options or to change displays.

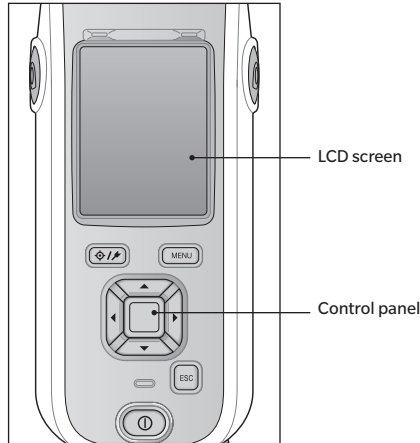

□ Display (LCD Screen)

The LCD screen displays measurement settings, measurement results, and messages. It also indicates the status of the instrument with icons.

The basic screen layout is shown below.

The screenshot shows the following screen layout with annotations:

- Status bar:** Displays battery level, signal strength, and time (12:34).
- Target/Sample:** Shows 'Sample' and '0003 Bumper'.
- Data number and name:** Shows '0004' and 'No Name'.
- Measurement area:** A table of colorimetric data:

L*	99.07	99.03
a*	-0.09	-0.05
b*	0.03	0.01
ΔL*	0.08	0.07
Δa*	-0.05	0.05
Δb*	0.01	-0.08
ΔE*ab	0.09	0.12
GU	94.26	94.26
ΔGU	0.10	0.10
MI	0.13	0.13
- Measurement date/time:** Shows '2016/07/21 11:56:14'.
- Target reference (Sample), or group (Target):** Shows '0002 Panel'.
- Pass/fail result:** A red 'X' icon is shown next to the 'No Name' label.
- Measurement area:** The value '0.12' in the ΔE*ab row is highlighted in red.
- MAV:** A 'MAV' icon is shown in the bottom right corner.
- Display type of currently displayed screen:** A row of icons at the bottom indicates the current display mode.

□ Status Bar

This section describes the icons displayed at the top of the screen.

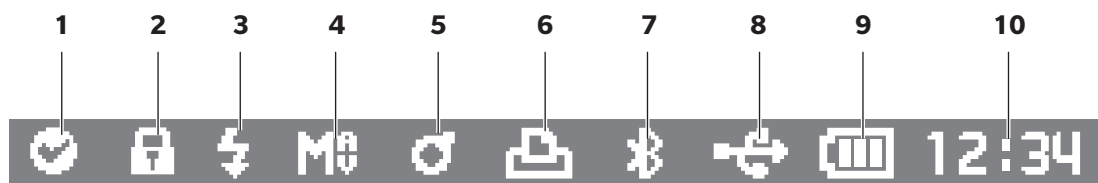

	Display	Description (Status)	Meaning
1	/ / None	Equipment diagnosis result	Pass / Warning / No diagnosis
2	/ None	Protect data	No overwriting, editing, or deletion of target data / No data protection
3	/	Flash status	Flash ready / Insufficient light
4	/	Measurement area	MAV / SAV
5	/ /	Calibrating	Measurement possible / Measurement possible (calibration recommended) / Calibration required
6	/ None	Auto print ON	
7	/ None	Wireless communication Bluetooth ON	
8	/ / None	Communication status	Remote / Remote measurement possible / Communication OFF
9	/ None	Power status	Power status Battery capacity (Full/OK/Low) / Charging / Battery degradation status (Full/OK/Low/None) / External power supply at Full
10	12:34	Current time	Hour : Minute

□ Control Keys

Use these keys to set items or change screens according to the guide on the LCD screen.

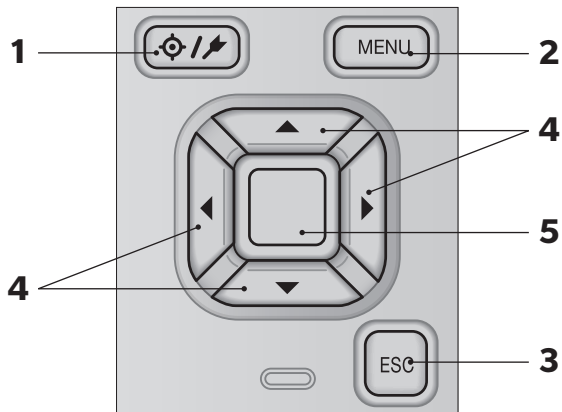

- 1 [**Target/Sample**] key
(Target/Sample) key
Switches between the **<Target> screen** and **<Sample> screen**.
- 2 [**MENU**] key
Displays the **<Settings> screen**.
- 3 [**ESC**] key
Returns to the previous screen without configuring the settings when pressed on the **<Settings> screen**, and returns to list screen when pressed on the sample details screen.
- 4 [**Left, Right, Up, Down**] keys
Switches screen tabs from the **<Result> screen**, moves the cursor on the **<Settings> screen**, or changes the selected value.
- 5 [**Confirmation**] key
Sets the item or setting indicated by the cursor on the various setting screens. This key also switches to detail screens for data selected in the list displayed on the **<Result> screen**.

Changing Screens

Results Display screen (When the target is displayed, there will be no screen displaying the color difference.)

[Confirmation] key Details display	[ESC] key Details display List display	[Left] key Move to previous/next page Move to previous/next display type	[Up/Down] key Select the previous/next data Display the previous/next data	[MENU] key Details display Details display	[F4/F5] key Target/Sample switching Target/Sample switching
---------------------------------------	--	--	--	--	---

[Target] List
Use [Left] or [Right] to move between pages.

[Target] Details
Absolute value

Use [Left] or [Right] to go to the next display type.

Abs. Graph

Spectral Graph

[Sample] List
Use [Left] or [Right] to move between pages.

[Sample] Details
Absolute value

Use [Left] or [Right] to go to the next display type.

Abs. & Diff.

Difference

Pass/Fail

Custom 1/2

Abs. Graph

Diff. Graph

Spectral Graph

The detail screen is displayed only for screens with the appropriate format selected under <Display type>.

MENU [F4] ESC or MENU When displaying the target color, first access the Target menu, and when displaying the sample, first access the Sample menu.

[Various setting menus (Option menu)]
Use [Left] or [Right] to go to the next menu. Use [Up] or [Down] to select an item, and then press the [Confirmation] key to finalize.

Target menu

Sample menu

Measurement cond.

Setting

Calibration

■ Menus

Target menu	
Print data	P.57

Edit name	P.58
-----------	------

Data management	
Delete data	P.59
	OK/Cancel

Set group	P.60
	OK/Cancel
	Edit group

Change list position	P.61
	Target No. selection

Edit Target filter	P.62
	OFF/ON/only group

Protect data	P.63
	OFF/ON

Delete all data	P.64
	OK/Cancel

Pass/Fail	
Edit tolerance	P.66
	OK/Cancel

Tolerance list	P.67
	Index selection

Warning level	P.68
	0 to 100%

Parametric coef.	P.69
	I (CMC), c (CMC), I (ΔE^*94), c (ΔE^*94), h (ΔE^*94), I ($\Delta E00$), c ($\Delta E00$), h ($\Delta E00$)

Input colorimetric data	
Color space	P.70
	XYZ/L*a*b*/Hunter Lab

Input data	P.71
------------	------

Sample menu	
Print data	P.45

Edit name	P.46
-----------	------

Data management	
Delete data	P.47
	OK/Cancel

Set Sample as Target	P.48
	Target No. selection

Change Target reference	P.49
	Target No. selection

Change list position	P.50
	Sample No. selection

Delete all data	P.51
	OK/Cancel

Auto target	
Auto target	P.52
	OFF/ON

Threshold	P.53
	0.01 to 9.99

Measurement cond.	
Measurement mode	P.82
	Color & Gloss / Color only / Gloss only

Measurement setup	
Auto average	P.84
	1 to 10 Times

Manual average	P.85
	1 to 30 Times

Manual average option	P.85
	Manual save
	Auto save

SMC	P.86
	OFF/ON

SMC Threshold	P.87
	0.01 to 9.99

SMC Times	P.88
	3 to 10 times

Observer/Illuminant	
Observer/Illuminant 1	P.90

2° A/C/D50/D65/ID50/
ID65/F2/F6/F7/F8/F10/
F11/F12/User
10° A/C/D50/D65/ID50/
ID65/F2/F6/F7/F8/F10/
F11/F12/User

Observer/Illuminant 2	P.92
-----------------------	------

2° A/C/D50/D65/ID50/
ID65/F2/F6/F7/F8/F10/
F11/F12/User
10° A/C/D50/D65/ID50/
ID65/F2/F6/F7/F8/F10/
F11/F12/User/None

Display cond.	
Display type	P.94

Absolute value, Difference,
Abs. & Diff., Pass/Fail,
Custom, Abs. Graph, Diff.
Graph, Spectral Graph

Color space	P.95
-------------	------

L*a*b*, L*C*h, Hunter Lab,
Yxy, XYZ, Munsell (C)

Equation	P.96
ΔE^*ab , CMC, ΔE^*94 , $\Delta E00$, ΔE (Hunter), $\Delta E99o$	

Custom 01 to 14	P.97
L^* , a^* , b^* , ΔL^* , Δa^* , Δb^* , C^* , h , ΔC^* , ΔH^* , L , a , b , ΔL , Δa , Δb , X , Y , Z , ΔX , ΔY , ΔZ , x , y , Δx , Δy , H , V , C , ΔE^*ab , CMC, ΔE^*94 , $\Delta E00$, ΔE (Hunter), MI , GU , ΔGU , WIe , ΔWIe , WIc , ΔWIc , $Tint$, $\Delta Tint$, Yle , ΔYle , Yld , ΔYld , B , ΔB , $\Delta E99o$, UE , UC	

Setting

Default data setup	P.73
Default tolerance	P.75
OK/Cancel	

Warning level	P.76
0 to 100%	

Parametric coef.	P.77
I (CMC), c (CMC), I (ΔE^*94), c (ΔE^*94), h (ΔE^*94), I ($\Delta E00$), c ($\Delta E00$), h ($\Delta E00$)	

Set group	P.78
Group number selection → Group name setting	

Calibration setup

Calibration interval	P.122
01 to 24 h	

Annual calibration	P.123
OFF/ON	

User calibration	P.124
OFF/ON	

Communication setup

Auto print	P.119
OFF/ON	

Bluetooth	P.112
OFF/ON	

Meter PIN code	P.113
4 to 8 digits (Default: 0000)	

Printer address	P.116
000000000000	

Printer PIN code	P.117
4 to 8 digits (Default: 0000)	

Scanner address	P.116
000000000000	

Scanner PIN code	P.117
4 to 8 digits (Default: 0000)	

Instrument setup

User type	P.99
Administrator / Worker	

Language	P.100
English/Japanese/German/ French/Spanish/Italian/ Chinese/Portuguese/ Polish/Russian/Turkish	

Date format	P.101
$[yyyy/mm/dd]$ / $[mm/dd/yyyy]$ $[dd/mm/yyyy]$	

Date & time	P.102
0000/00/00 00:00:00	

Brightness	P.103
5/4/3/2/1	

Beep	P.105
OFF/ON	

Auto power off	P.106
00 to 60 (minute)	

Diagnosis info.	P.125
Diagnosis info. display	

Instrument info.	P.126
Product name, Version, Serial No.	

Calibration

Calibration (Including Zero Cal.)	P.32
Zero calibration → White calibration → Gloss calibration	

Calibration (Excluding Zero Cal.)	P.34
White calibration → Gloss calibration	

■ Data Saving

Data used with this instrument are saved automatically within the instrument.

Data on the instrument can also be imported to a PC using the optional Color Data Software “SpectraMagic DX” or “SpectraMagic NX”.

Chapter 2

Measurement

Flow of Measurement	27
Preparation	28
Calibration	32
Zero Calibration	32
White Calibration and Gloss Calibration	34
User Calibration	36
Setting a Specimen	37
Viewfinder	37
Measurement	38
Measurement/Data Display Screen	39
Measurement (Simple Mode)	42
Handling the Sample	44
Print	45
Edit Name	46
Sample Data Management	47
Auto Target (Sample)	52
Pass/Fail Judgment for Color Difference	54
Pass/Fail Judgment Based on Tolerances	54
Color Difference Target Color Operation	56
Print	57
Edit Name	58
Target Data Management	59
Pass/Fail	65
Input Colorimetric Data	70
Default Data Settings	73

Flow of Measurement

■ Optional Settings

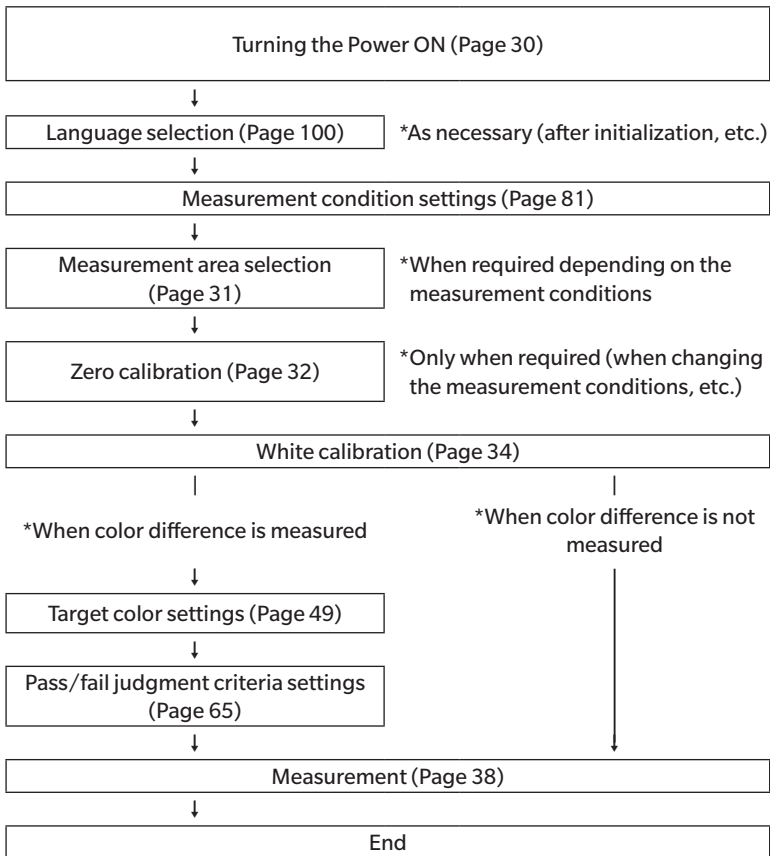

■ Basic Procedure

■ Simple measurement

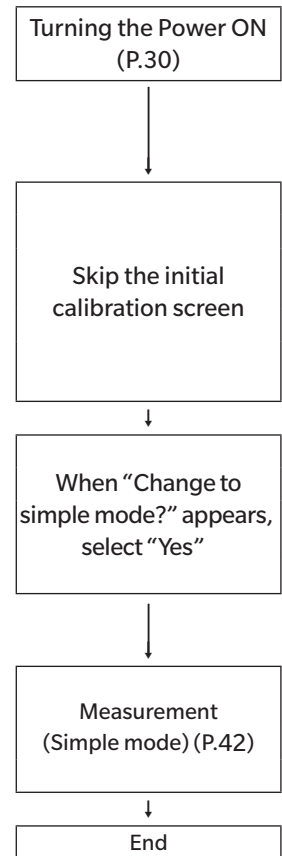

* Configure measurement/ observation conditions and perform calibration as necessary.

Preparation

□ Attaching the Wrist Strap

Attaching the wrist strap

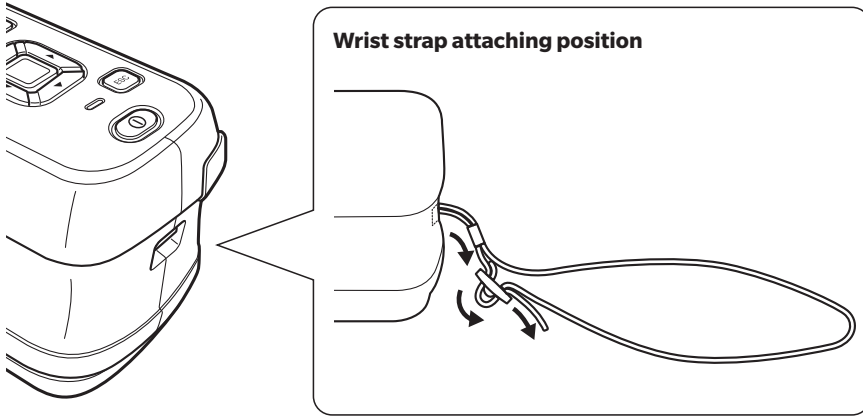

□ Inserting the Battery

This instrument can be powered from a lithium-ion battery, but use of the AC adapter or USB bus power is recommended for extended periods of use. A lithium-ion battery installed in the instrument will be charged whenever the AC adapter or USB bus power is used, regardless of whether the instrument is turned ON or OFF.

Notes When using USB bus power, use a PC that meets IEC 62368-1 (Audio/video, information and communication technology equipment - Part 1: Safety requirements) standards.

⚠ CAUTION

- Do not touch or short-circuit the terminals in the battery compartment. Doing so may damage the instrument.

Operating Procedure

- 1 Turn the instrument power OFF by pressing the power button.
- 2 Slide the battery compartment cover on the bottom of the instrument.

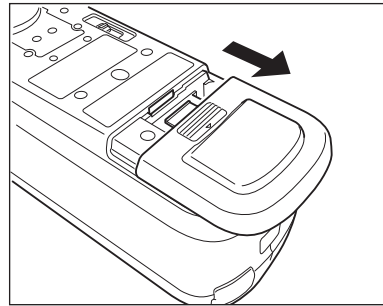

- 3 Rotate the battery retainer and insert the lithium-ion battery. (Follow the indications in the battery compartment to avoid confusing the battery polarity.)

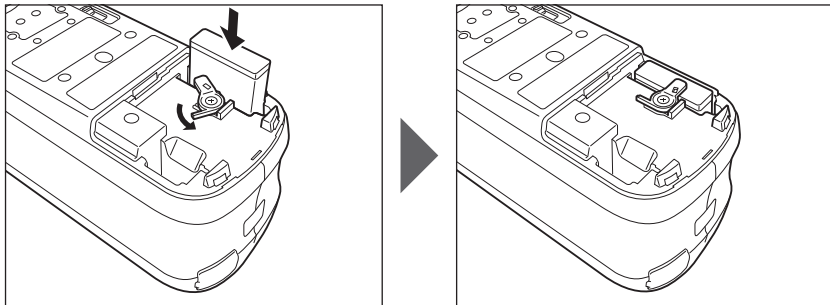

- 4 Slide the battery compartment cover to close it.

□ Connecting the AC Adapter

- Notes**
- The lithium-ion battery must always be installed, even when using external power.
 - To supply AC power to the instrument, always use the AC adapter (AC-A305J/L/M) supplied with the instrument.
 - Firmly push the AC adapter power plug or USB cable completely into the outlet.

Memo Powering the instrument from the USB cable will charge the lithium-ion battery. While the battery is charging, the charging lamp on the instrument's panel will light up orange. When charging is complete, the lamp will turn green.

Operating Procedure

- 1 Open the connector's protective cover, and connect the USB cable to the USB port on the instrument.

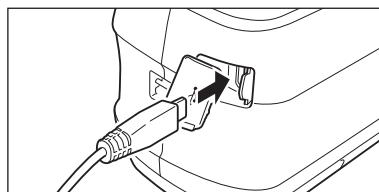

- 2 Connect the USB cable to the AC adapter, and then connect the AC adapter plug to a 100-240 VAC (50/60 Hz) power outlet.

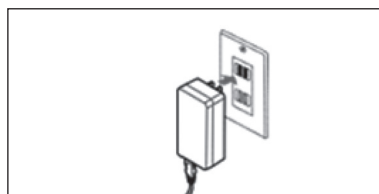
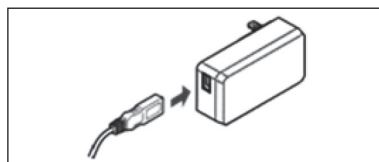

□ Turning the Power ON/OFF

Operating Procedure

Turning the Power ON

- 1 With the power OFF, press and hold the power switch for about 1 second.

The power will turn ON.

- Notes**
- When first turning the instrument ON after purchasing, the language setting screen will be displayed, followed by the date and time setting screen. Configure the settings according to pages 100 and 102.

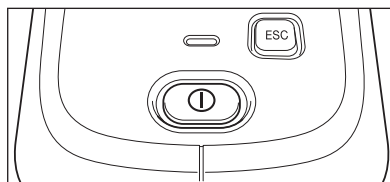

Operating Procedure

Turning the Power OFF

- 1 Press and hold the power switch for about 1 second. The power will turn OFF after the settings have been saved.

- Memo** When powered by the battery, the instrument will turn OFF automatically after 5 minutes of inactivity. Due to data protection within the instrument, powering down may take several seconds to several tens of seconds.

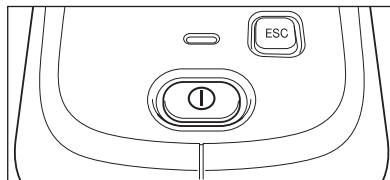

□ Measurement Area Selection

Select the measurement area.

The selected measurement area can be checked on the status bar displayed on the screen. (Refer to page 20.)

Operating Procedure

Operate the measurement area switch on the instrument.

- 1 Use the measurement area switch on the bottom of the instrument to set the measurement area to MAV or SAV.

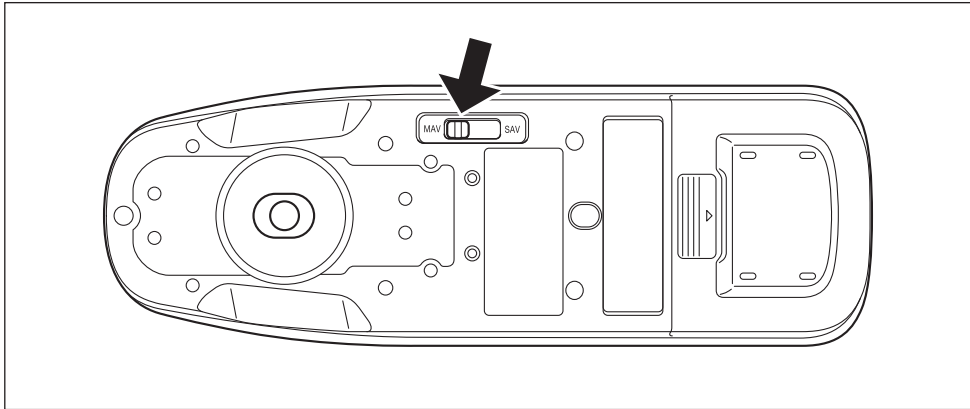

Settings

- MAV: Measurement area of 8 mm (10 mm with gloss measurement)
- SAV: Measurement area of 3 mm

Using the optional stapler type target mask (CM-A216) makes it possible to accurately aim where measurement will be performed.

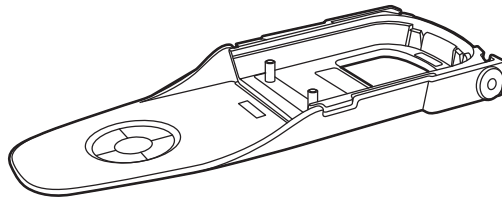

Calibration

Select the measurement area using the switch beforehand.

The following three types of calibration can be performed with this instrument.

- Zero calibration: Only the amount of stray light is measured in advance in order to eliminate the effects of the stray light.
- White calibration: The reflectance is measured in advance using a known calibration plate in order to provide a reflectance scale.
- Gloss calibration: The gloss is measured in advance using a known calibration plate in order to provide a gloss scale.
This calibration is performed after white calibration with this instrument.

Calibration Stage

Use a calibration stage with the same number as that printed on the nameplate of the instrument.

Newly purchased calibration stages will have a different number than that shown on the nameplate of the instrument. Make sure the calibration plate ID displayed on the <Calibration> screen matches the calibration stage number.

Zero Calibration

Since this instrument stores the data of the previous zero calibration, repeating zero calibration every time the instrument is turned ON is not necessary. If, however, the measurement conditions change greatly, or if the instrument is not used for a long period of time, zero calibration must be performed before white calibration.

- Memo**
- The effects of stray light (i.e., light generated due to the flare characteristics of the optical system) will be compensated for automatically by the zero calibration data.
 - The amount of stray light may change because of dust or dirt that has collected in the optical system, humidity, repeated operation, or vibration and shock exerted on the instrument. In this case, performing zero calibration periodically is recommended.

- Notes**
- **If the instrument is not used for long periods of time, the zero calibration data stored in the instrument may be lost. If the data is lost, zero calibration must be performed again.**

Operating Procedure

Start the procedure from the measurement screen.

- 1 Press [MENU], and then use [◀] or [▶] to display the <Calibration> screen.

- Notes**
- **The following screen prompting calibration is displayed when the instrument starts up. If zero calibration has not been performed, the cursor will appear on "Calibration (Including Zero Cal.)". Otherwise, the cursor will appear on "Calibration (Excluding Zero Cal.)".**

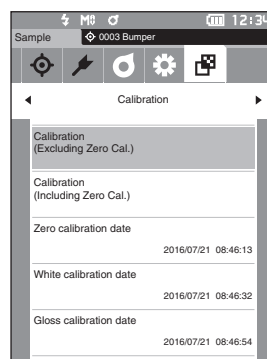
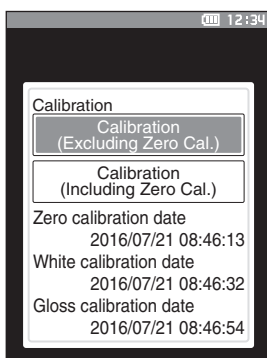

2 Use [▲] or [▼] to move the cursor to “Calibration (Including Zero Cal.)”, and then press the [Confirmation] key.

3 Set the instrument in the calibration stage to measure the calibration stage’s zero calibration hole.

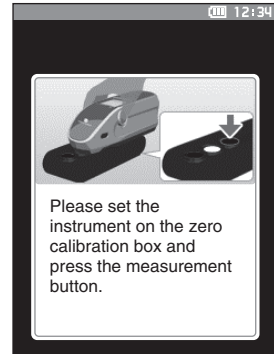
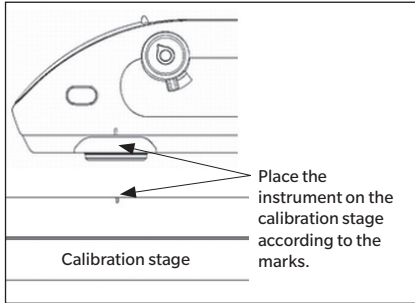

4 Press the measurement button.

Zero calibration will be performed. When the zero calibration is completed, a screen prompting white calibration is displayed. Continue to step 3 on the following page to perform white calibration.

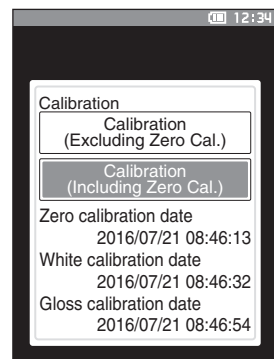
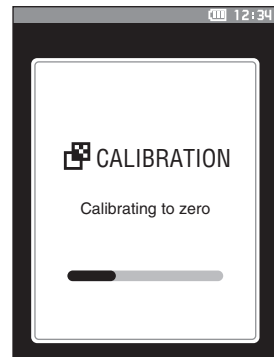

■ White Calibration and Gloss Calibration

A message prompting white calibration is displayed on the instrument after the power is turned ON.

- Memo**
- If the calibration interval is turned ON and a time is configured, a message prompting white calibration will be displayed the next time the power is turned ON or when measurement is performed after the set time has passed since the previous white calibration. (Refer to page 122 “Calibration Interval Messages”.)
 - The reading may fluctuate slightly due to changes in the ambient temperature or due to heat generation caused by repeated operation of the instrument. In such cases, perform white calibration regularly.
 - Calibration details may vary according to the measurement mode (Refer to page 82). When the measurement mode is set to “Color & Gloss”, white calibration and gloss calibration will be performed. When the mode is set to “Color only”, only white calibration will be performed. When the mode is set to “Gloss only”, only gloss calibration will be performed.

- Notes**
- **White calibration must be performed at the same temperature at which measurement will be performed.**
 - **Perform white calibration after the instrument has had time to adapt to the ambient temperature.**

Operating Procedure

Start the procedure from the measurement screen.

Although white calibration can be performed from the prompt when the power is turned ON and from the screen following zero calibration, the following explains the procedure to perform white calibration from the measurement screen.

1 Press [MENU], and then use [◀] or [▶] to display the <Calibration> screen.

- Notes**
- **The following screen prompting calibration is displayed when the instrument starts up. If zero calibration has not been performed, the cursor will appear on “Calibration (Including Zero Cal.)”. Otherwise, the cursor will appear on “Calibration (Excluding Zero Cal.)”.**

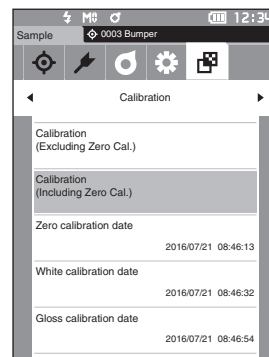
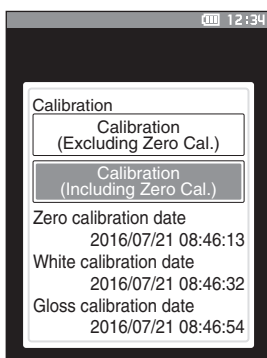

2 Use [▲] or [▼] to move the cursor to “Calibration (Excluding Zero Cal.)”, and then press the [Confirmation] key.

3 Set the instrument in the calibration stage in order to measure the calibration stage's white calibration plate.

- Notes**
- Verify that the White ID shown on the screen and the calibration stage number match.

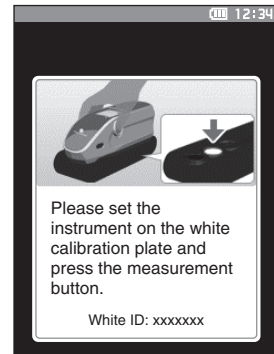
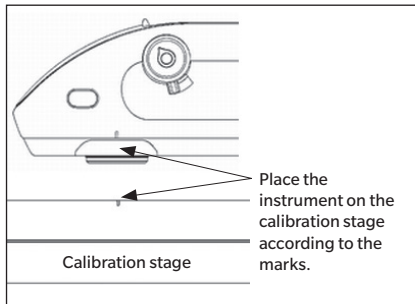

4 Press the measurement button.

White calibration will be performed.
After white calibration is complete, a screen prompting gloss calibration will be displayed.



5 Set the instrument in the calibration stage in order to measure the calibration stage's gloss calibration plate.

- Notes**
- Verify that the Gloss ID shown on the screen and the calibration stage number match.

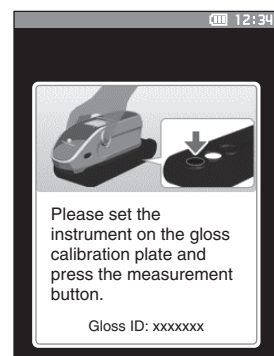
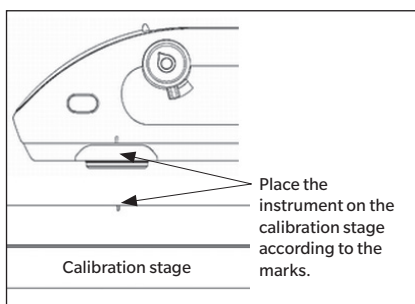

6 Press the measurement button.

Gloss calibration will be performed.
When gloss calibration is completed, the screen returns to the one displayed before the <Calibration> screen.



■ User Calibration

You can perform calibration by using your own reference plate and calibration data instead of white calibration. The calibration data for user calibration can be specified by connecting the instrument to a PC and using the optional Color Data Software "SpectraMagic DX". Select whether to use the user calibration data for measurement on the "Calibration setup" > "User Calibration" (refer to page 124) of the instrument.

Operating Procedure

Start the procedure from the measurement screen.

1 Perform user calibration instead of white calibration.

Notes Before user calibration can be set to ON, user calibration data must be prepared and written to the instrument memory.

2 Set the instrument on the user tile so that the measuring port is over the tile.



3 Press the measurement button.

User calibration will be performed. When the user calibration is completed, the screen returns to the one displayed before the <Calibration> screen.

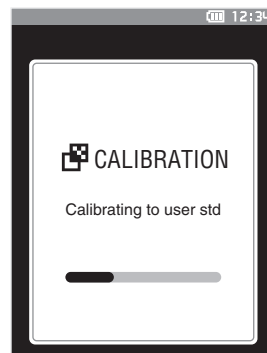

Setting a Specimen

To measure with this instrument, select the measurement area and set the instrument on the specimen. Either MAV or SAV can be selected as the measurement area depending on the specimen being measured and the application.

Notes Switch the measurement area to be measured using the measurement area switch.

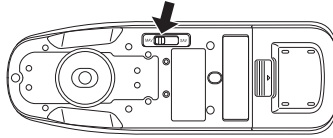

■ Viewfinder

This instrument allows users to check the measurement points for a specimen when using the instrument for measurement.

How to Use

- 1 Set the instrument on top of the specimen.
- 2 Slide the viewfinder lever to open the viewfinder. (The viewfinder and viewfinder levers are located on the left and right side of the instrument. Either can be used to confirm the position of the sample.)

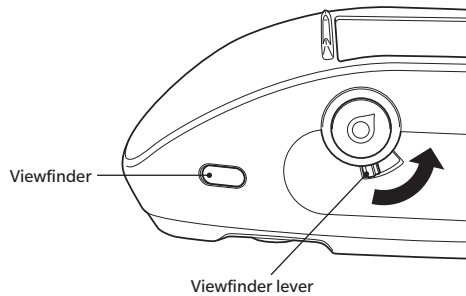

- 3 As the viewfinder opens, a white LED will turn ON, illuminating the specimen within the range of measurement according to the set measurement area (MAV/SAV).

Memo The LED illuminates the MAV measurement range at first. When the measurement range is set to SAV, the SAV measurement range is illuminated when the measurement button is pushed.

- 4 Look into the viewfinder and adjust the position of the specimen.

Memo Look into the viewfinder from an angle that allows the user to see the measuring port.

- 5 Close the viewfinder. (The white LED will turn OFF.)

Notes If the reflectance of the specimen to be measured is low, the measurement range may not be clearly visible even when illuminated by a white LED. Also, if the specimen has a mirror surface or a surface similar to a mirror surface, the illumination light may not be clearly visible. In such cases, use the optional stapler type target mask (CM-A216).

Measurement

Notes

- Prior to the start of measurement, be sure to perform white calibration. For details, refer to “White Calibration and Gloss Calibration” on page 34.
- To display the color difference, target colors must be set before measurement.
- To measure a target, select the target number before measurement.
- For accurate measurement, make sure to keep measurement conditions (ambient temperature, etc.) constant.

Operating Procedure

1 Press [◊/↗] to bring up the [Target] or [Sample] screen, depending on the objective.

The <Target> screen or the <Sample> screen is displayed.

Note: If the menu screen is displayed, press [ESC] and perform the operation after the Results Display screen is displayed.

Sample	0003 Bumper	
0003	Sample	
1	10°/D65	
2	2°/C	
L*	99.06	99.01
a*	-0.05	-0.04
b*	0.02	0.05
ΔL*	0.07	0.05
Δa*	-0.01	0.06
Δb*	0.00	-0.04
ΔE*ab	0.07	0.09
GU	94.06	94.06
ΔGU	0.10	0.10
MI	0.08	0.08
2016/07/21 13:52:16		
0002 Panel		

2 Set the specimen measuring port on the sample to measure.

- Take care to prevent displacement or tilting from occurring.
- Using the optional stapler type target mask (CM-A216) makes it possible to determine the measurement position more accurately.

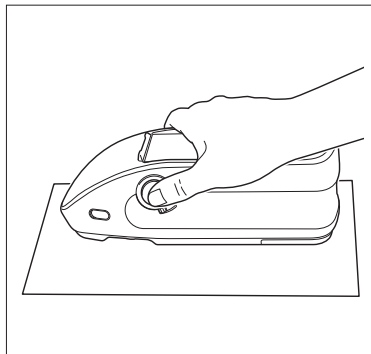
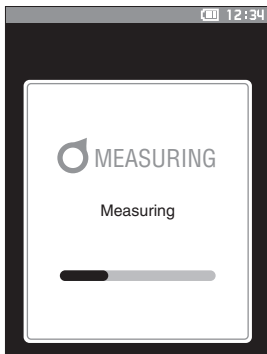

To measure concave surfaces, as shown in the following figure, use the standard flat type battery cover (CM-A218).

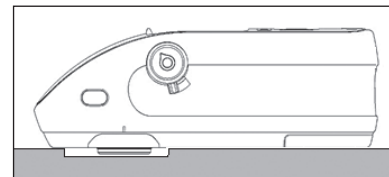

3 Press the measurement button.

The specimen is measured and the results are displayed on the screen.

- The selected number will be used as the target data number. If data is already present for that number, a confirmation dialog will ask if the data should be overwritten. Press the [Confirmation] key to overwrite.
- The sample data No. is automatically assigned sequentially in the order of measurements.

Sample	0003 Bumper	
0004	No Name	
1	10°/D65	
2	2°/C	
L*	99.07	99.03
a*	-0.09	-0.05
b*	0.03	0.01
ΔL*	0.08	0.07
Δa*	-0.05	0.05
Δb*	0.01	-0.08
ΔE*ab	0.09	0.12
GU	94.26	94.26
ΔGU	0.10	0.10
MI	0.13	0.13
2016/07/21 11:56:14		
0002 Panel		

Memo

- When the number of sample data sets stored in the memory reaches 7,500, “The device memory is full. Please delete some data to measure.” will be displayed, indicating that some data sets must be deleted before measurement is possible.

■ Measurement/Data Display Screen

Target List Screen

- For every data entry, the target No. and name is displayed in the column above, and the measurement date and time are displayed in the column below. A pseudocolor is displayed at the right end only if data exists. However, no pseudocolor is displayed when measuring only gloss.
- The cursor will appear at the currently selected target.
- Press the [Confirmation] key or [ESC] to bring up the target detail screen and display the currently selected target's detailed data.
- Press [▲] to select (move the cursor to) the previous target.
- Press [▼] to select (move the cursor to) the following target.
- Press [◀] to display the previous list screen. The cursor will move to the top target.
- Press [▶] to display the following list screen. The cursor will move to the top target.

Target Detail Screen

- The target No. and name is displayed below the target tab.
- Failure to set Observer/Illuminant 2 will cause the data value column to be blank.
- The Gloss column will be blank if the measurement mode is set to "Color only".
- The measurement date and time as well as the set group number will be displayed below the data value column.
- The measurement area will be displayed in the lower-right corner of the data value column.
- An exclamation mark (ⓘ) will be displayed when a measurement is performed with an insufficient illumination or the calibration interval has arrived, or when the result is outside the guaranteed range.
- A display showing the overall page count and the position on the current page is available at the bottom of the screen.
- The number of pages to display is determined by the <Display type> setting.
- Press [ESC] to bring up the Target list screen. The cursor will appear at the currently selected target.
- Press [▲] to display the previous target.
- Press [▼] to display the following target.
- Press [◀] to bring up the previously displayed page.
- Press [▶] to bring up the following displayed page.

Common Aspects of List and Detail Screens

- The settings for the currently selected filter are displayed to the right of the Target tab.
- If no data exists, the data value column will be blank.
- Press [⊕/↗] to bring up the Sample screen.
- Press [MENU] to bring up the <Target menu> screen.
- Pressing the measurement button will cause the <Measuring> screen to be displayed and measurement to begin.
- When <Protect data> is turned ON, a message saying so will be displayed and measurement will not be possible. Select "OK" to return to the previous screen.
- If calibration is required (if calibration has not yet been performed or if the calibration interval has been exceeded), a message will be displayed prompting calibration. Select "OK" to bring up the calibration screen. Selecting "Cancel" will cause the display to return to the previous screen without performing calibration.
- If data already exists, an overwrite confirmation message will appear. Select "OK" or press the measurement button to measure. Selecting "Cancel" will cause the display to return to the previous screen without performing measurement.
- When <Beep> is ON, the buzzer will go off once after successful completion and 3 times when an error occurs.
- After successful completion of the measurement, the data will be saved to the selected target number.
- Measurements outside the measurement range will be indicated by "Out of Guaranteed Range" displayed for the measurement value on the screen.
- If an error occurs during measurement, an error indication message will be displayed. Select "OK" to return to the previous screen.
- In general, the screen will return to the previous screen (page) after measurement. However, if the manual average count is two or more, the Manual average screen will be displayed (refer to page 85).

Sample List Screen

- If the data does not exist, the measurement list screen will not be displayed.
- For every data entry, the sample No. and name is displayed in the column above, and the measurement date and time are displayed in the column below. A pseudocolor is displayed at the right end only if data exists. However, no pseudocolor is displayed when measuring only gloss.
- The cursor will appear at the currently selected sample.
- Press the [Confirmation] key or [ESC] to bring up the Sample detail screen and display the currently selected sample's detailed data.
- Press [▲] to select (move the cursor to) the previous sample.
- Press [▼] to select (move the cursor to) the following sample.
- Press [◀] to display the previous list screen. The cursor will move to the top sample number.
- Press [▶] to display the following list screen. The cursor will move to the top sample number.

Sample Detail Screen

- If no data exists, the data value column will be blank.
- The sample No. and name is displayed below the sample tab.
- Failure to set Observer/Illuminant 2 will cause the data value column to be blank.
- The Gloss column will be blank if the measurement mode is set to "Color only".
- The measurement date and time as well as related target information will be displayed below the data value column.
- The measurement area will be displayed in the lower-right corner of the data value column.
- An exclamation mark Ⓢ will be displayed when a measurement is performed with an insufficient illumination or the calibration interval has arrived, or when the result is outside the guaranteed range.
- A display showing the overall page count and the position on the current page is available at the bottom of the screen.
- The number of pages to display is determined by the <Display type> setting.
- Press [ESC] to bring up the Sample list screen. The cursor will appear at the currently selected sample.
- Press [▲] to display the previous sample.
- Press [▼] to display the following sample.
- Press [◀] to bring up the previously displayed page.
- Press [▶] to bring up the following displayed page.

Common Aspects of List and Detail Screens

- The target No. and name displayed on the currently selected target details screen will be displayed to the right of the Target tab.
- Press [Ⓢ/⚡] to bring up the Target screen.
- Press [MENU] to bring up the <Sample menu> screen.
- Pressing the measurement button will cause the <Measuring> screen to be displayed and measurement to begin.
- If calibration is required (if calibration has not yet been performed or if the calibration interval has been exceeded), a message will be displayed prompting calibration. Select "OK" to bring up the calibration screen. Selecting "Cancel" will cause the display to return to the previous screen without performing calibration.
- If the maximum number of measurements has been reached, an error indication message will be displayed and measurement will not be possible. Select "OK" to return to the previous screen.
- When <Beep> is ON, the buzzer will go off once after successful completion and 3 times when an error occurs.
- After successful completion of the measurement, the new data will be added to the end of the measurement number.
- If an error occurs during measurement, an error indication message will be displayed. Select "OK" to return to the previous screen.
- In general, the screen will return to the previous screen (page) after measurement. However, if the manual average count is two or more, the Manual average screen will be displayed (refer to page 85).

Changing Screens

The detail screen is displayed only for screens with the appropriate format selected under <Display type>.

[Target] List
Use [◀] or [▶] to move between pages.

confirmation
ESC
↕
ESC

[Target] Details Use [◀] or [▶] to go to the next display type.

Absolute value Custom Abs. Graph Spectral Graph

↑↓◊/⚡(Target/Sample)
[Sample] List
Use [◀] or [▶] to move between pages.

confirmation
ESC
↕
ESC

[Sample] Details Use [◀] or [▶] to go to the next display type.

Absolute value Difference Abs. & Diff. Pass/Fail

Custom 1/2 Abs. Graph Diff. Graph Spectral Graph

Measurement (Simple Mode)

Used to easily confirm color differences. The menu items that can be set in Simple mode are as follows.

Setting Procedure

1 Set to "Simple mode".

Press [ESC] to skip the calibration displayed immediately after turning the power ON.

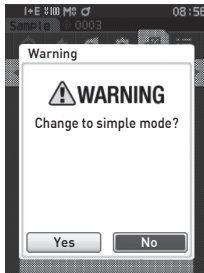
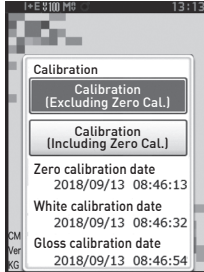

When "Change to simple mode?" appears on the screen, select "Yes".

Set "Simple mode" under <Setting> - <Instrument Mode>.

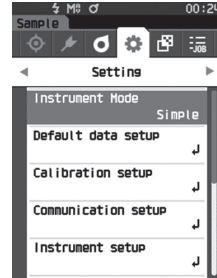

Press the [Target/Sample] button or the [ESC] button to switch to the Simple Measurement screen.

2 Measuring a target: Absolute value measurement

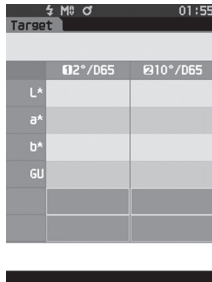

Press the measurement button.

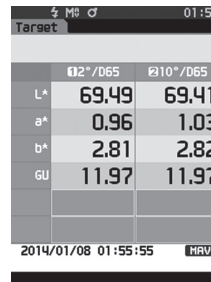

3 Measuring a sample: Difference measurement

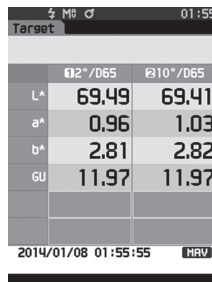

Press the measurement button.

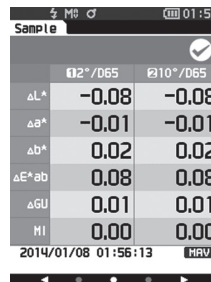

Notes Data is not saved when measuring in Simple mode.

4 Press the measurement button to continue measuring color differences. To change the target, press [Target/Sample] to measure the target again.

Memo To exit Simple mode, turn the instrument OFF or select "Normal" under [MENU] - <Settings> - <Instrument setup>.

Handling the Sample

<Screen transition>

The keys can be used to switch between screens displaying the data.

On the **<Sample menu> screen**, the following operations are available for the sample data.

<Print data>

Print the current sample data with the printer.

<Edit name>

Name the sample data.

<Data management>

- Delete data : Delete the selected sample data.
- Set Sample as Target : Set sample data as target color data.
- Change Target reference : Change target reference.
- Change list position : Jump to the specified sample data.
- Delete all data : Delete all sample data.

<Auto target>

During measurement, the color difference target with the smallest color difference value is automatically selected.

Setting Procedure

Start the procedure from the measurement screen.

- 1 Press [MENU], and then use [◀] or [▶] to display the **<Sample menu> screen**.

Memo To return to the **previous screen**, press [MENU] or [ESC].

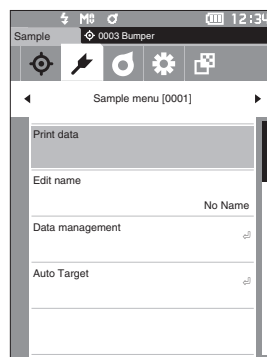

Print

Print the sample data. The instrument must be connected to the serial printer in advance. For instructions on how to connect the instrument to a serial printer, refer to page 115 "Connecting to a Printer/Barcode Reader".

- Notes**
- Display the sample to be printed on the <Sample> screen in advance.
 - If a proper connection is not established, printing will not be possible.
 - Even if the connection has been correctly established, printing may fail for reasons such as the printer being turned off when printing is attempted.

Setting Procedure

Start the procedure from the <Sample menu> screen.

- 1 Use [▲] or [▼] to move the cursor to "Print data", and press the [Confirmation] key. Printing will begin from the connected printer.

When printing is complete, the screen returns to the <Sample> screen.

- Notes** The <Print> screen is displayed even when data will not be printed properly due to an improper printer connection or other problem.

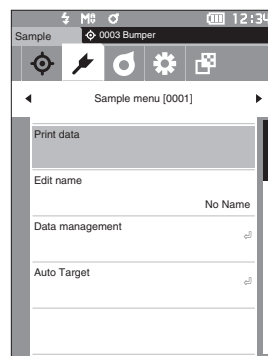

```
S/N xxxxxxxx
SAMPLE0003
[Sample]
2016/07/21 11:54:16
  10/065 2/C
L* 99.06 99.01
a* -0.05 -0.04
b* 0.02 0.05
GU 94.06
```

■ Edit Name

Name the sample data.

Display the name of the sample to be edited on the <Sample> screen in advance.

Setting Procedure

Start the procedure from the <Sample menu> screen.

- 1 Use [▲] or [▼] to move the cursor to “Edit name”, and then press the [Confirmation] key. The <Edit name> screen is displayed.

- 2 Use [▲]/[▼] or [◀]/[▶] to move the cursor between characters, and then press the [Confirmation] key.
 - Up to 30 characters can be used.
 - The selected character is displayed in the text box.
 - If the name is obtained from the barcode reader, the name will be set as the name for the sample data.

- 3 Repeat step 2 until the necessary characters have been entered.
 - To delete the character to the left of the cursor in the text box, move the cursor to [✕] and press the [Confirmation] key.

- 4 After inputting the characters, move the cursor to [OK] and press the [Confirmation] key. The setting is confirmed and the screen returns to the <Sample> screen.

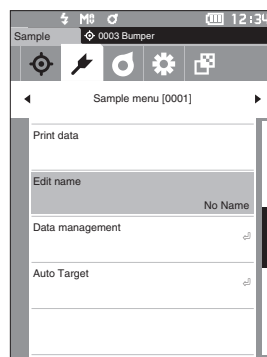

- Memo**
- If [ESC] is pressed during configuration, or if the cursor is moved to “Cancel” and the [Confirmation] key is pressed, the settings will not be changed and the screen will return to the <Sample menu> screen.
 - When using a barcode reader, barcodes can be used on the <Edit name> screen. Refer to pages 115 to 117 “Connecting to a Printer/Barcode Reader” for information on connecting a barcode reader.

■ Sample Data Management

Sample data management allows users to delete sample data, copy the sample to the target, change the link to the target, change the list position, and delete all data.

Setting Procedure

Start the procedure from the <Sample menu> screen.

- 1 Use [▲] or [▼] to move the cursor to “Data management”, and then press the [Confirmation] key to display the <Data management> screen.

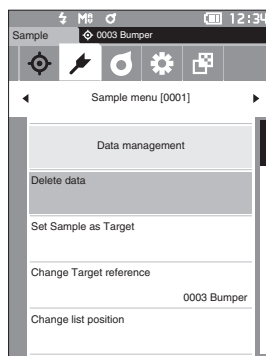
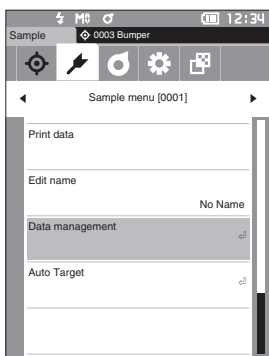

□ Delete

Delete the sample data.

Display the sample to be deleted on the <Sample> screen in advance.

Setting Procedure

Start the procedure from the <Sample menu> - <Data management> screen.

- 1 Use [▲] or [▼] to move the cursor to “Delete data”, and then press the [Confirmation] key. The <Delete data> screen is displayed.

- 2 Use [◀] or [▶] to move the cursor to “OK” and press the [Confirmation] key to delete.

Memo When data is deleted, the subsequent sample data numbers will be reassigned, reducing each by one.

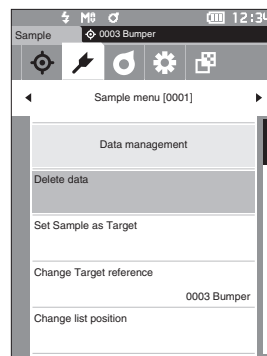

- When the deletion is complete, the screen returns to the <Sample> screen.
- Moving the cursor to “Cancel” and pressing the [Confirmation] key will cancel the deletion, and the screen will return to the <Data management> screen.

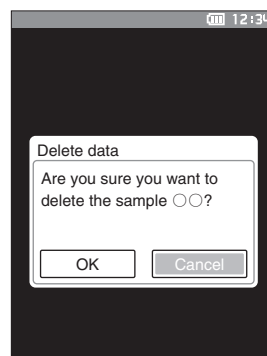

□ Set Sample as Target

Sample data can be copied to target data and registered.
Display the sample to be set as the target on the <Sample> screen in advance.

Setting Procedure

Start the procedure from the <Sample menu> - <Data management> screen.

- Memo**
- Target colors are stored with setting numbers from 0001 to 2500 being assigned. Even when the data at some point is deleted, these setting numbers do not change. Grouping data by assigning numbers of specific digits is useful.
 - To set more accurate target color data, use averaging to measure the target specimen. For details, refer to the section on average measurement on pages 84 and 85.

- Notes**
- **Be sure to perform white calibration before setting target colors.**
 - **To ensure measurement accuracy, make sure to keep ambient conditions (temperature, etc.) constant.**
 - **Unlike measured data, the numbers assigned to target color data do not change automatically. When measuring colors continuously to set target colors, the cursor must be moved manually to set each data.**

- 1 Use [▲] or [▼] to move the cursor to “Set Sample as Target”, and then press the [Confirmation] key. The <Set Sample as Target> screen is displayed.

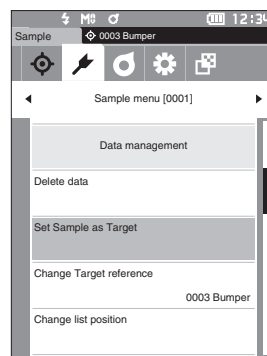

- 2 The target color data number being used will be highlighted. Use [▲] or [▼] to move the cursor to the color difference reference color number, and then press the [Confirmation] key. When the target color data is set, the screen returns to the <Target> screen.

- If [ESC] is pressed without pressing the [Confirmation] key, the screen will return to the <Target> screen.

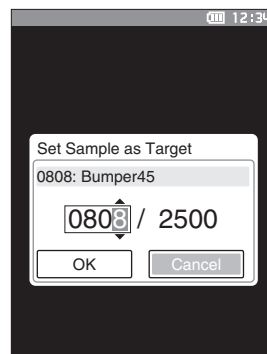

- Notes**
- If a number to which target color data has already been set is selected, a message is displayed to confirm overwriting. Use [◀] or [▶] to select “OK”. Press the [Confirmation] key. Moving the cursor to “Cancel” and pressing the [Confirmation] key will cancel the deletion, and the screen will return to the <Target> screen.

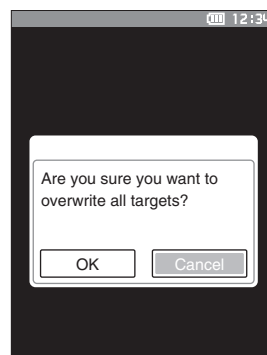

□ Change Target Reference

The target data acting as a reference for the sample data can be changed.

Display the sample for which the target reference is to be changed on the <Sample> screen in advance.

Setting Procedure

Start the procedure from the <Sample menu> - <Data management> screen.

- 1 Use [▲] or [▼] to move the cursor to “Change Target reference”, and then press the [Confirmation] key.

The <Change Target reference> screen is displayed.

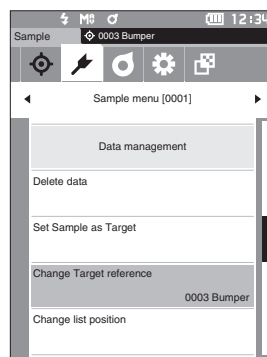

- 2 The target color data number being used will be displayed. Use [▲] or [▼] to move the cursor to the color difference reference color number, and then press the [Confirmation] key. When the target color data is set, the screen returns to the <Sample> screen.

- If [ESC] is pressed, the target changes will not be applied and the screen will return to the <Data management> screen.

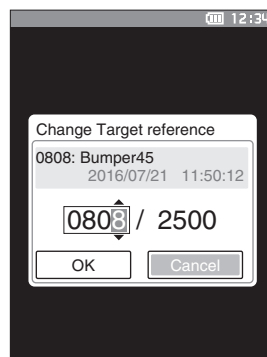

Notes If a number to which no color difference target data has been set, the target will be determined as “None” and the color difference and pass/fail judgment will not be displayed.

□ Change List Position

Specifying sample numbers allows for specified sample to be selected without the need to scroll the screen.

Setting Procedure

Start the procedure from the <Sample menu> - <Data management> screen.

- 1 Use [▲] or [▼] to move the cursor to “Change list position”, and then press the [Confirmation] key. The <Change list position> screen is displayed.

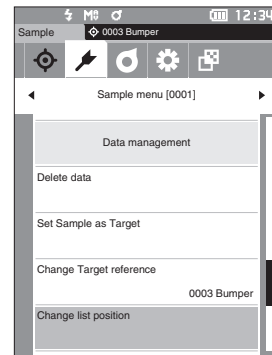

- 2 ▲ and ▼ will be displayed above and below the data number. Use [▲] or [▼] to specify a value. Use [◀] or [▶] to move between digits.

- 3 Press the [Confirmation] key. The selection is confirmed and the screen returns to the <Sample> screen.

Notes If [ESC] is pressed without pressing the [Confirmation] key, the settings will not be changed and the screen will return to the <Data management> screen.

Notes Numbers with no measurement data cannot be selected.

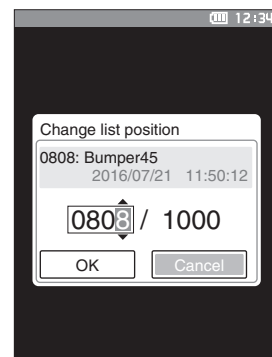

□ Delete All Data

Delete all sample data.

Setting Procedure

Start the procedure from the <Sample menu> - <Data management> screen.

- 1 Use [▲] or [▼] to move the cursor to “Delete all data”, and then press the [Confirmation] key. The <Delete all data> screen is displayed.

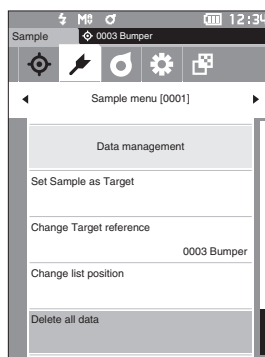

- 2 Use [◀] or [▶] to move the cursor to “OK” and press the [Confirmation] key to delete all data.
 - When the deletion is complete, the screen returns to the <Sample> screen.
 - Moving the cursor to “Cancel” and pressing the [Confirmation] key will cancel the deletion of all data, and the screen will return to the <Data management> screen.

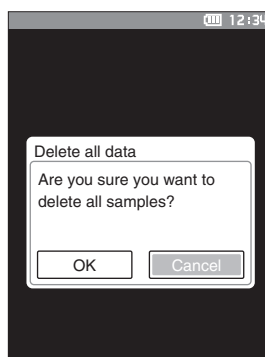

■ Auto Target (Sample)

During measurement, the color difference target with the smallest color difference value is automatically selected. Color difference targets with a smaller color difference value than the preset threshold are displayed in ascending order from the target with the smallest color difference. The color difference target to use can be selected from among the displayed targets. If only one color difference target has a color difference value less than the threshold, that color difference target will be automatically selected.

Memo The color difference is calculated using the color difference equation set for the instrument.

- Notes**
- Do not use this function to manage the color difference from a specific target.
 - This function is not applied to sample data obtained before the function was turned ON.

Setting Procedure

Start the procedure from the <Sample menu> screen.

- 1 Use [▲] or [▼] to move the cursor to “Auto Target”, and then press the [Confirmation] key to display the <Auto Target> screen.

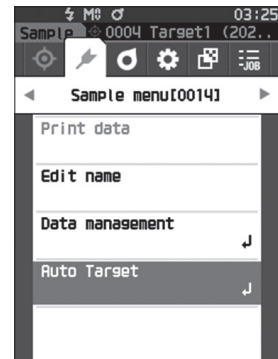

□ Auto Target (Sample)

Setting Procedure

Start the procedure from the <Sample menu> - <Auto Target> screen.

- 1 Use [▲] or [▼] to move the cursor to “Auto Target”, and then press the [Confirmation] key. The <Auto Target> screen is displayed.

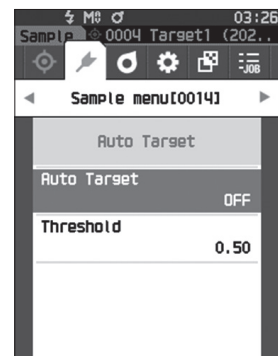

2 Use [▲] or [▼] to move the cursor to “ON” or “OFF”.

Settings

- ON : The automatic target selection function will be used.
- OFF : The automatic target selection function will not be used.

3 Press the [Confirmation] key.

The selection is confirmed and the screen returns to the <Auto Target> screen.

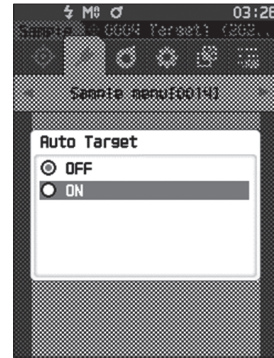

□ Threshold (Sample)

Sets the threshold to be used for the automatic target selection function.

Setting Procedure

Start the procedure from the <Sample menu> - <Auto Target> screen.

1 Use [▲] or [▼] to move the cursor to “Threshold”, and then press the [Confirmation] key.

The <Threshold> screen is displayed.

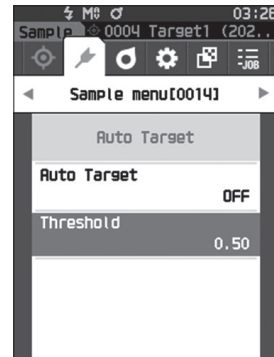

2 ▲ and ▼ are displayed above and below the number to be set.

Use [▲] or [▼] to specify a value.

Settings

- 0.01 to 9.99

3 Press the [Confirmation] key.

The selection is confirmed and the screen returns to the <Auto Target> screen.

Notes If [ESC] is pressed without pressing the [Confirmation] key, the settings will not be changed and the screen will return to the <Auto Target> screen.

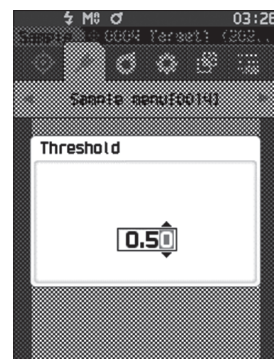

Pass/Fail Judgment for Color Difference

With this instrument, tolerances can be set for the color difference of the sample data from the target color data to perform judgment. For the procedure on setting tolerances, refer to page 66 “Tolerance Settings” and page 75 “Default Tolerance Setting”.

If target color data is deleted, neither the color difference display for the data nor the pass/fail judgment based on the tolerances set to the data will be performed. If other target color data is selected, or another target color is assigned to the target color number of the deleted data, recalculations and pass/fail judgments will be performed.

■ Pass/Fail Judgment Based on Tolerances

If the measured color difference is outside the tolerances set for the target color, the value will be highlighted in red to indicate that the judgment result is “Fail”. By setting the warning level (page 68), even if the sample does not exceed the tolerance, that item will be highlighted with yellow and a warning will be issued if the sample nears the tolerance. Both maximum and minimum tolerances can be set for each target color. Pass/fail judgments based on color difference tolerances are displayed as follows.

Notes Before using this function, the color difference tolerances must be set.

<Sample> Display Screen

Notes If no relevant target data has been set, no color difference value or pass/fail mark will be displayed.

○ Display when all of color differences and gloss value differences do not exceed or near the tolerance

Absolute value, Difference, Abs. & Diff., and Custom screens

Ex.: Abs. & Diff. screen

	1 10°/D65	2 2°/C
L*	99.06	99.01
a*	-0.05	-0.04
b*	0.02	0.05
ΔL*	0.07	0.05
Δa*	-0.01	0.06
Δb*	0.00	-0.04
ΔE*ab	0.07	0.09
GU	94.06	94.06
ΔGU	0.10	0.10
MI	0.08	0.08

"PASS" is printed in the print output.

Pass/Fail screen

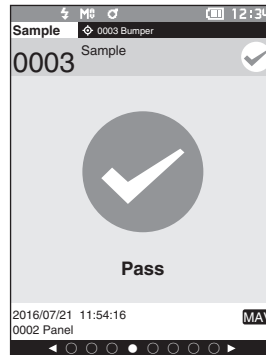

The pass mark and "Pass" are displayed.

○ Display when any color difference or gloss value difference nears the tolerance

Absolute value, Difference, Abs. & Diff., and Custom screens

Ex.: Abs. & Diff. screen

	1 10°/D65	2 2°/C
L*	99.06	99.02
a*	-0.05	-0.04
b*	0.02	0.03
ΔL*	0.07	0.06
Δa*	-0.01	0.06
Δb*	0.00	-0.06
ΔE*ab	0.07	0.10
GU	94.06	94.06
ΔGU	0.10	0.10
MI	0.08	0.08

"WARNING" is printed in the print output, and "w" is appended after any value near the tolerance.

Pass/Fail screen

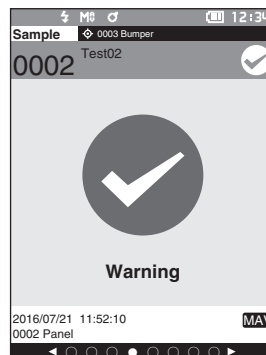

"Warning" is displayed, and the mark changes to yellow.

○ Display when any color difference or gloss value difference exceeds the tolerance

Absolute value, Difference, Abs. & Diff., and Custom screens

Ex.: Abs. & Diff. screen

	1 10°/D65	2 2°/C
L*	99.07	99.03
a*	-0.09	-0.05
b*	0.03	0.01
ΔL*	0.08	0.07
Δa*	-0.05	0.05
Δb*	0.01	-0.08
ΔE*ab	0.09	0.12
GU	94.26	94.26
ΔGU	0.10	0.10
MI	0.13	0.13

"FAIL" is printed in the print output, and "x" is appended after any value that exceeds the tolerance.

Pass/Fail screen



"Fail" is displayed, and the mark changes to red.

Color Difference Target Color Operation

To measure the color difference between two specimens, the color of one of the specimens must be set as the target color. This instrument can store up to 2,500 target colors and 7,500 sample colors.

- Memo**
- Target colors are stored with setting numbers from 0001 to 2500 being assigned. Even when the data at some point is deleted, these setting numbers do not change. It is useful to group data by assigning numbers of specific digits.
 - To set more accurate target color data, use averaging to measure the target specimen. For details, refer to the section on average measurement on pages 84 and 85.

- Notes**
- **Be sure to perform white calibration before setting target colors.**
 - **To ensure measurement accuracy, make sure to keep ambient conditions (temperature, etc.) constant.**

The **<Target menu> screen** allows the following operations for target color data.

<Print data>

Print the current target color data with the printer.

<Edit name>

Name the target data.

<Data management>

- Delete data : Delete the selected target color data.
- Set group : Configure the target color group.
- Change list position : Jump to the specified target color data.
- Edit Target filter : Displays the target color data that meets the specified conditions.
- Protect data : Protects all target color data. New measurements are still possible.
- Delete all data : Deletes all of the target color data.

<Input Colorimetric data>

Set the target by numerical input.

Operating Procedure

Start the procedure from the measurement screen.

- 1 Press [MENU], and then use [◀] or [▶] to display the **<Target menu> screen**.

Memo To return to the **previous screen**, press [MENU] or [ESC].

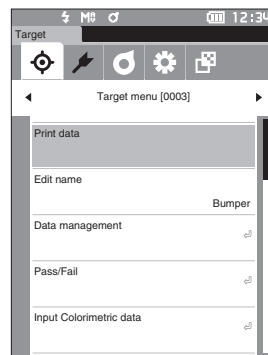

Print

Print the target color data. The instrument must be connected to the serial printer in advance. For instructions on how to connect the instrument to a serial printer, refer to page 115 “Connecting to a Printer/Barcode Reader”.

- Notes**
- Display the target color to be printed on the <Target> screen in advance.
 - If a proper connection is not established, printing will not be possible.
 - Even if the connection has been correctly established, printing may fail for reasons such as the printer being turned off when printing is attempted.

Operating Procedure

Start the procedure from the <Target menu> screen.

- 1 Use [▲] or [▼] to move the cursor to “Print data”, and press the [Confirmation] key. Printing will begin from the connected printer.

When the printing is complete, the screen returns to the <Target> screen.

- Notes** The <Print> screen is also displayed when printing will not be processed properly such as when the printer is not correctly connected.

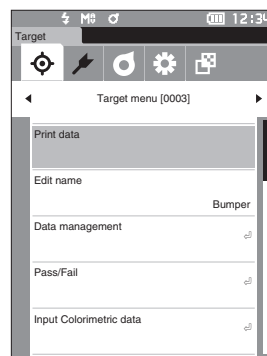

```
S/N xxxxxxxx
TARGET0002
[Panel ]
2016/07/21 11:50:12
10/D85 2/C
L* 98.99 98.96
a* -0.04 -0.10
b* 0.02 0.09
GU 94.16
```

■ Edit Name

Name the target color data.

Operating Procedure

Start the procedure from the <Target menu> screen.

- 1 Use [▲] or [▼] to move the cursor to “Edit name”, and then press the [Confirmation] key.

The <Edit name> screen is displayed.

- 2 Use [▲]/[▼] or [◀]/[▶] to move the cursor between characters, and then press the [Confirmation] key.

- Up to 30 characters can be used.
- The selected character is displayed in the text box.

- 3 Repeat step 2 until the necessary characters have been entered.

- To delete the character to the left of the cursor in the text box, move the cursor to [x] and press the [Confirmation] key.

- 4 After inputting the characters, move the cursor to [OK] and press the [Confirmation] key.

The setting is confirmed and the screen returns to the <Target> screen.

Memo

- If [ESC] is pressed during configuration, or if the cursor is moved to “Cancel” and the [Confirmation] key is pressed, the settings will not be changed and the screen will return to the <Target menu> screen.
- When using a barcode reader, barcodes can be used on the <Edit name> screen. Refer to pages 115 to 117 “Connecting to a Printer/Barcode Reader” for information on connecting a barcode reader.

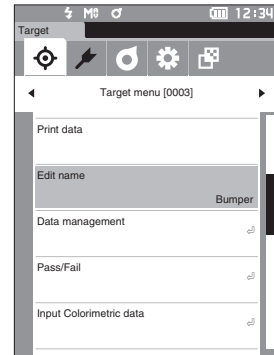

■ Target Data Management

Target data management allows users to enforce target data restrictions, perform grouping, change list positions, edit target filters, protect data, and delete all data.

Operating Procedure

Start the procedure from the <Target menu> screen.

- 1 Use [▲] or [▼] to move the cursor to “Data management”, and then press the [Confirmation] key to display the <Data management> screen.

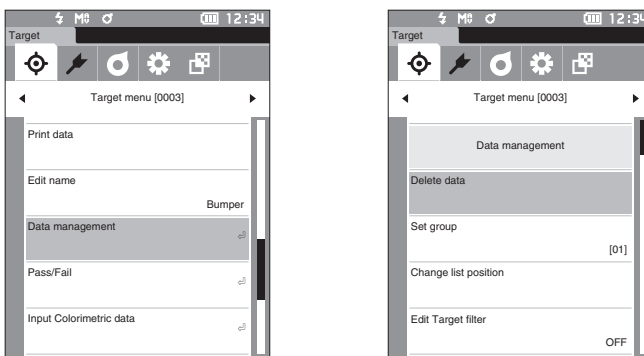

□ Delete

Delete the target color data.

Display the target color to be deleted on the <Target> screen in advance.

Operating Procedure

Start the procedure from the <Target menu> - <Data management> screen.

- 1 Use [▲] or [▼] to move the cursor to “Delete data”, and then press the [Confirmation] key. The <Delete data> screen is displayed.

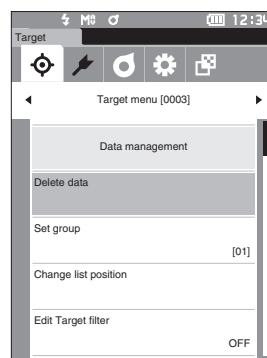

- 2 Use [◀] or [▶] to move the cursor to “OK” and press the [Confirmation] key to delete.

Memo Even if deletion is performed, numbers do not shift upward. That number for that measurement is instead left blank

- When the deletion is complete, the screen returns to the <Target> screen.
- Moving the cursor to “Cancel” and pressing the [Confirmation] key will cancel the deletion, and the screen will return to the <Data management> screen.

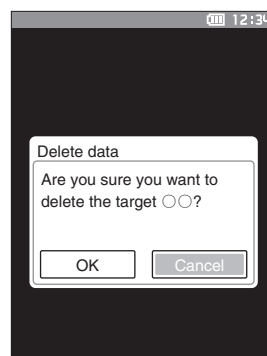

□ Set Group

In order to facilitate classification of targets into groups, up to five groups to which data should be categorized can be configured. After the targets have been registered to a group, the filtering function can be used to display only the selected target data. This section describes the registration of a group.

- Memo**
- If a new target color is measured, the measurement will be assigned to the appropriate group according to the default settings.
 - Display the group of the target color to be set on the <Target> screen in advance.

Operating Procedure

Start the procedure from the <Target menu> - <Data management> screen.

- 1 Use [▲] or [▼] to move the cursor to “Set group”, and then press the [Confirmation] key. The <Edit group> screen is displayed.

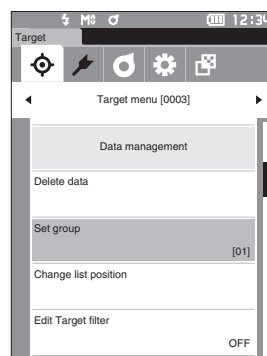

- 2 Use [▲] or [▼] to move to the cursor to the group number column to which the current target color should be applied, and then press the [Confirmation] key.

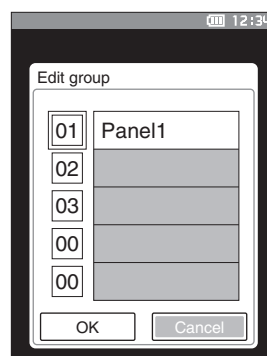

- 3 Use [▲] or [▼] to move the cursor to select the group value to which the target color should be applied, and then press the [Confirmation] key. The selection is confirmed and the screen returns to the <Target> screen.

- Memo** Group names configured in advance through <Default data setup> in accordance with group numbers are displayed.

- 4 Select “OK”. Selecting “Cancel” will cause the display to return to the <Data management> screen without changing the settings.

- Notes** If [ESC] is pressed without pressing the [Confirmation] key, the settings will not be changed and the screen will return to the <Data management> screen.

□ Change List Position

Specifying target numbers allows for specified targets to be displayed without the need to scroll the screen.

Operating Procedure

Start the procedure from the <Target menu> - <Data management> screen.

- 1 Use [▲] or [▼] to move the cursor to “Change list position”, and then press the [Confirmation] key. The <Change list position> screen is displayed.

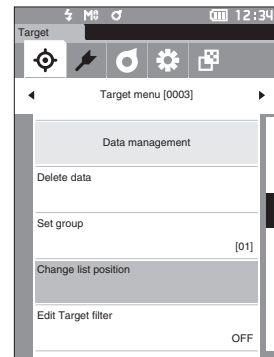

- 2 ▲ and ▼ will be displayed above and below the data number. Use [▲] or [▼] to specify a value. Use [◀] or [▶] to move between digits.

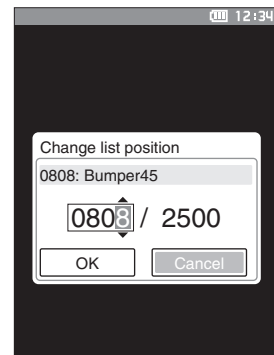

- 3 Press the [Confirmation] key. The selection is confirmed and the screen returns to the <Target> screen.

Notes If [ESC] is pressed without pressing the [Confirmation] key, the settings will not be changed and the screen will return to the <Data management> screen.

□ Edit Target Filter

The filter function makes searching for a target easier. The function allows only selected target data to be displayed by selecting only saved data or by selecting a group created in advance.

Memo The Edit Target filter is set to "OFF" when the instrument is shipped from the factory.

Operating Procedure

Start the procedure from the <Target menu> - <Data management> screen.

1 Use [▲] or [▼] to move the cursor to "Edit Target filter", and then press the [Confirmation] key. The <Edit Target filter> screen is displayed.

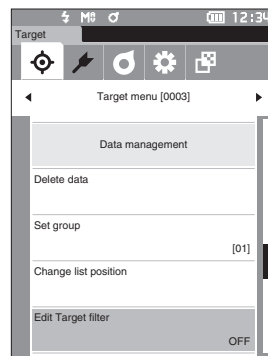

2 Use [▲] or [▼] to move the cursor to the desired item.

Settings

- OFF : All target color data will be displayed.
- only saved data : Displays only data for the set target.
- only group : Only targets that satisfy all of the group conditions displayed below are displayed. Select and press the [Confirmation] key to display the group selection screen. With the cursor on the group numbers, press the [Confirmation] key. Using [▲] or [▼] to select the group number displays the group name set for the default group. Press the [Confirmation] key to confirm, and press [OK] to return to the <Data management> screen.

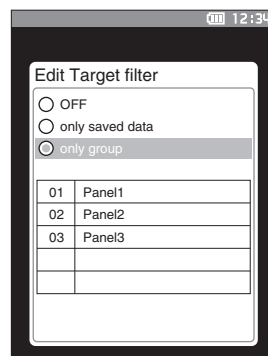

3 Press the [Confirmation] key. (With [OFF] and [only saved data])

The selection is confirmed and the screen returns to the <Target> screen.

Notes If [ESC] is pressed without pressing the [Confirmation] key, the settings will not be changed and the screen will return to the <Data management> screen.

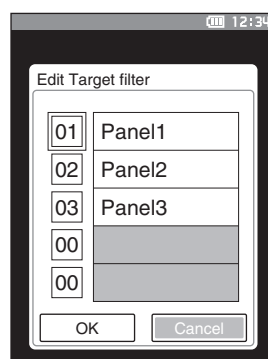

□ Data Protection

Data protection can be specified so that the saved target color settings will not be deleted or changed by accident. When the data protection is set, you cannot select “Edit name”, “Edit tolerance”, “Delete data” or “Delete all data” on the <Target menu> screen, and overwrite measurement cannot be performed.

Memo Protect data is set to “OFF” when the instrument is shipped from the factory.

Operating Procedure

Start the procedure from the <Target menu> - <Data management> screen.

- 1 Use [▲] or [▼] to move the cursor to “Protect data”, and then press the [Confirmation] key. The <Protect data> screen is displayed.

- 2 Use [▲] or [▼] to move the cursor to the desired item.

Settings

- OFF : Do not protect the data.
- ON : Protect the data.

- 3 Press the [Confirmation] key.

The selection is confirmed and the screen returns to the <Data management> screen. When protection is turned ON, the key icon indicating data protection is turned ON will be displayed in the status bar.

Notes If [ESC] is pressed without pressing the [Confirmation] key, the settings will not be changed and the screen will return to the <Data management> screen.

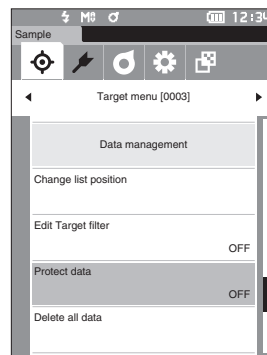

□ Delete All Data

Delete all the target color data that have been set.

Notes When the data is protected, “Delete all data” cannot be selected on the <Data management> screen.

Operating Procedure

Start the procedure from the <Target menu> - <Data management> screen.

- 1 Use [▲] or [▼] to move the cursor to “Delete all data”, and then press the [Confirmation] key. The <Delete all data> screen is displayed.
- 2 Use [◀] or [▶] to move the cursor to “OK” and press the [Confirmation] key to delete all data.
 - When the deletion is complete, the screen returns to the <Target> screen.
 - Moving the cursor to “Cancel” and pressing the [Confirmation] key will cancel the deletion of all data, and the screen will return to the <Data management> screen.

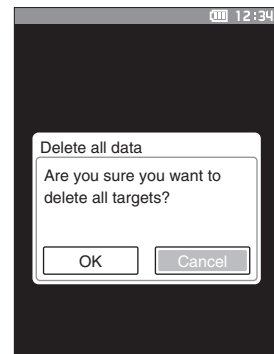
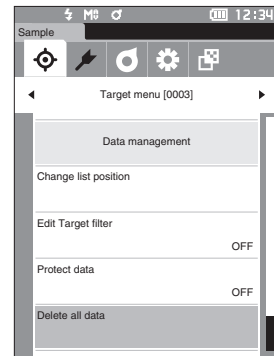

■ Pass/Fail

Edit the tolerance that will be used as the judgment criteria, and set the warning level and the parametric coefficient default value.

If the color difference between the sample and the target exceeds the tolerance, the column of the display color value relevant to the measurement display will be displayed in red. In addition, if even one display color value exceeds the tolerance, judgment will be shown as "Fail".

If the color difference between the sample and the target exceeds the warning level amount, the column of the display color value relevant to the measurement display will be displayed in yellow. In such cases, even if other display color values do not exceed the tolerance, judgment will be shown as "Warning".

- Memo**
- The default judgment criteria is set before judgment criteria for each target is set. For details, refer to page 73 "Default Data Settings".
 - The tolerance setting items are the same as those for the color space or index currently selected for the display conditions.
 - The optional Color Data Software "SpectraMagic DX" allows for easy configuration and use of judgment criteria.
 - Display the target to be set in advance before moving to <Target menu>.

Operating Procedure

Start the procedure from the <Target menu> screen.

- 1 Use [▲] or [▼] to move the cursor to "Pass/Fail", and then press the [Confirmation] key. The <Pass/Fail> screen will be displayed.

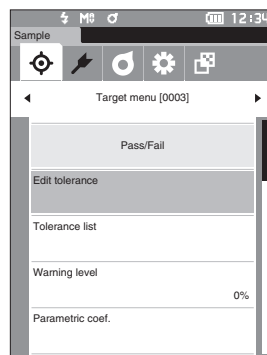
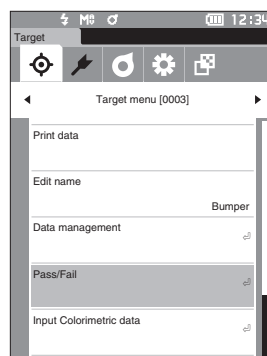

□ Tolerance Settings

Specify the tolerance used for pass/fail judgment of measured data for each target color.

Operating Procedure

Start the procedure from the <Target menu> - <Pass/Fail> screen.

- 1 Use [**▲**] or [**▼**] to move the cursor to “Edit tolerance”, and then press the [**Confirmation**] key.

The tolerance list screen is displayed.

- 2 Use [**▲**] or [**▼**] to move the cursor to the item to be set, and then press the [**Confirmation**] key.

The <Edit tolerance> screen is displayed.

- 3 Use [**▲**]/[**▼**] or [**◀**]/[**▶**] to move the cursor to the item to set and press the [**Confirmation**] key to change the item.

- When the selected item is not currently checked, pressing the [**Confirmation**] key causes the item to be checked, after which the setting value can be changed.
- Press [**◀**] or [**▶**] to move the cursor to the setting value area. Pressing the [**Confirmation**] key causes the cursor to appear on the value. Press [**▲**] or [**▼**] to change the value.
Move the cursor between the digits of the value by pressing [**◀**] or [**▶**].

Settings

- x / y : -0.2000 to 0.2000
- Color difference equation/MI : 0.00 to 20.00
- Other than the above : -20.00 to 20.00
- Press the [**Confirmation**] key to confirm every time the setting of an item is changed.

- 4 After all settings have been configured, use [**▲**] or [**▼**] to move the cursor to “OK”, and then press the [**Confirmation**] key.

The setting is confirmed and the screen returns to the <Pass/Fail> screen.

If [**ESC**] is pressed during setup, the settings will not be changed and the screen will return to the <Pass/Fail> screen.

- 5 Press [**ESC**] to return to the <Pass/Fail> screen.

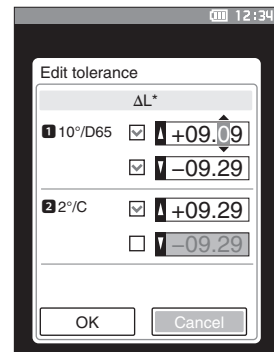
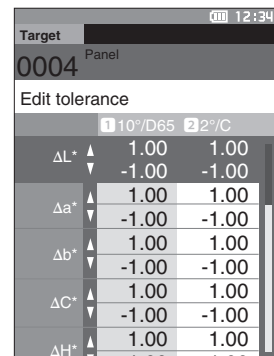
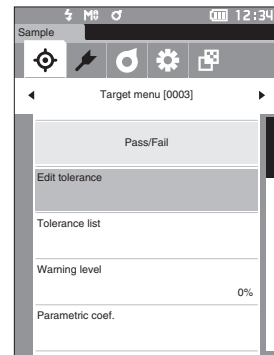

□ Tolerance List

Select the index used for sample pass/fail judgment.

Operating Procedure

Start the procedure from the <Target menu> - <Pass/Fail> screen.

- 1 Use [▲] or [▼] to move the cursor to “Tolerance list”, and then press the [Confirmation] key.

The available tolerances are displayed.

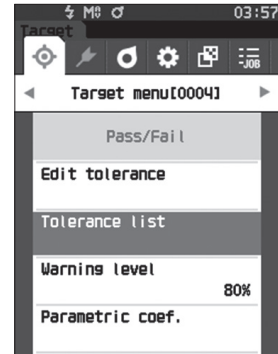

- 2 Use [▲] or [▼] to move the cursor to the item to set, and then press the [Confirmation] key.

- When the selected item is not currently checked, pressing the [Confirmation] key causes the item to be checked. When the selected item is currently checked, pressing the [Confirmation] key causes the item to be unchecked.
- Up to 14 indexes can be selected.

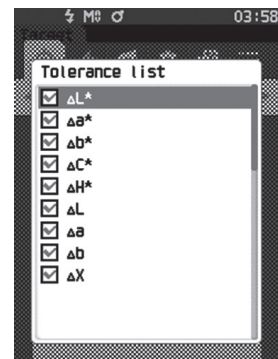

- 3 After all settings have been configured, use [▲] or [▼] to move the cursor to “OK”, and then press the [Confirmation] key.

The setting is confirmed and the screen returns to the <Pass/Fail> screen.

Pressing the [ESC] while configuring the settings will prevent the settings on the currently opened screen from being applied and revert all settings to the previous condition.

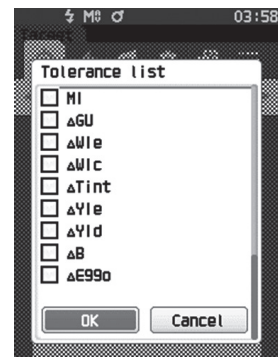

- 4 Press [ESC] to return to the <Pass/Fail> screen.

□ Warning Level Setting

Warnings are displayed when the measured data nears but does not exceed the tolerance. Users can set how close the data must be to the tolerance before a warning occurs.

Operating Procedure

Start the procedure from the <Target menu> - <Pass/Fail> screen.

- 1 Use [▲] or [▼] to move the cursor to “Warning level”, and then press the [Confirmation] key. The <Warning level> screen is displayed.

- 2 Use [▲] or [▼] to change the value.

Settings

- 000 to 100%

- 3 Press the [Confirmation] key after completing the changes.

The setting is confirmed and the screen returns to the <Pass/Fail> screen.

Notes If [ESC] is pressed during configuration, the settings will not be changed and the screen will return to the <Pass/Fail> screen.

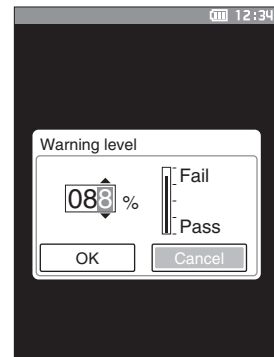
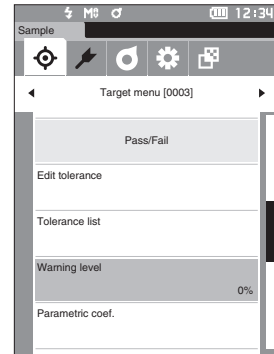

□ Parametric Coefficient Setting

Specify the parametric coefficient used for pass/fail judgment of measured data for each target color.

Operating Procedure

Start the procedure from the <Target menu> - <Pass/Fail> screen.

- 1 Use [▲] or [▼] to move the cursor to “Parametric coef.”, and then press the [Confirmation] key. The <Parametric coef.> screen is displayed.

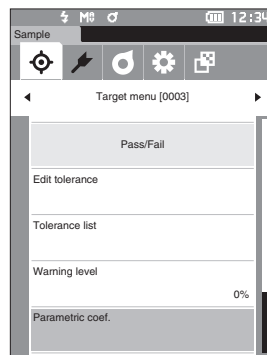

- 2 Use [▲] or [▼] to move the cursor to the item to be set, and then press the [Confirmation] key. The <Parametric coef.> edit screen is displayed.

- 3 Use [▲] or [▼] to move the cursor to the item to set and press the [Confirmation] key to change the item.
 - Pressing the [Confirmation] key causes the cursor to appear on the value. Press [▲] or [▼] to change the value. Move the cursor between the digits of the value by pressing [◀] or [▶].

Settings

- 0.01 to 9.99
- Press the [Confirmation] key to confirm every time the setting of an item is changed.

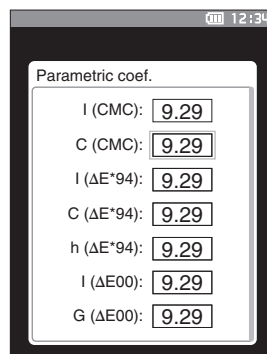

- 4 After all settings have been configured, use [▲] or [▼] to move the cursor to “OK”, and then press the [Confirmation] key. The setting is confirmed and the screen returns to the <Pass/Fail> screen.

Notes If [ESC] is pressed during setup, the settings will not be changed and the screen will return to the <Pass/Fail> screen.

- 5 Press [ESC] to return to the <Pass/Fail> screen.

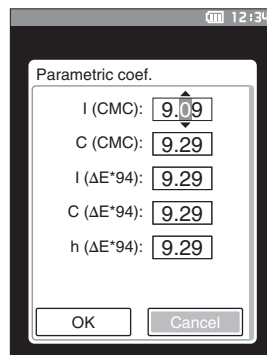

Input Colorimetric Data

Set the target by numerical input.

Select or specify the following items as the Input Colorimetric data.

- Color space: XYZ / L*a*b* / Hunter Lab
- Input Data: Enter the numeric value of the color space set above

Operating Procedure

Start the procedure from the <Target menu> screen.

- 1 Use [▲] or [▼] to move the cursor to “Input Colorimetric data”, and then press the [Confirmation] key to display the <Input Colorimetric data> screen.

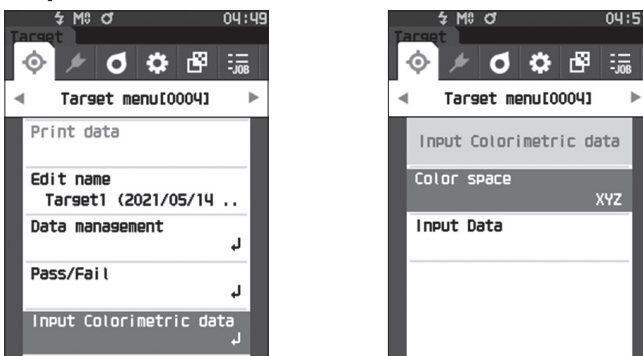

Color space

Specify which color space to input the colorimetric data.

Operating Procedure

Start the procedure from the <Target menu> - <Input Colorimetric data> screen.

- 1 Use [▲] or [▼] to move the cursor to “Color space”, and then press the [Confirmation] key. The <Color space> screen is displayed.

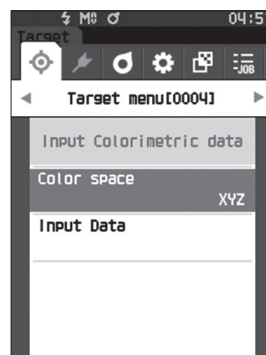

2 Use [▲] or [▼] to move the cursor to the item to set.

Settings

- XYZ: XYZ color space
- L*a*b: L*a*b* color space
- Hunter Lab: Hunter Lab color space



3 Press the [Confirmation] key.

The setting is confirmed and the screen returns to the <Input Colorimetric data> screen.

Notes If [ESC] is pressed during configuration, the settings will not be changed and the screen will return to the <Input Colorimetric data> screen.

□ Input Data

Create the color values for the color space selected in "Input Colorimetric data"- "Color space".

Operating Procedure

Start the procedure from the <Target menu> - <Input Colorimetric data> screen.

1 Use [▲] or [▼] to move the cursor to "Input Data", and then press the [Confirmation] key.

The Input data list screen is displayed.

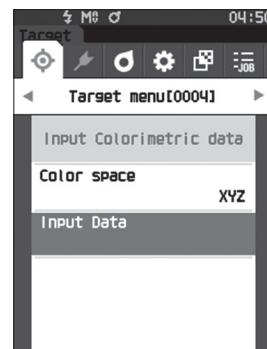

- 2 Use [▲] or [▼] to move the cursor to the item to set, and then press the [Confirmation] key. The <Input data> screen is displayed.

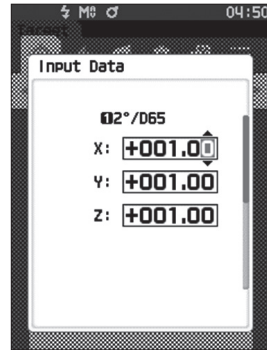

- 3 Use [▲] or [▼] to move the cursor to the item to set, and press the [Confirmation] key to change the setting.

- Press [◀] or [▶] to move the cursor to the setting value area. Pressing the [Confirmation] key causes the cursor to appear on the value. Press [▲] or [▼] to change the value. Move the cursor between the digits of the value by pressing [◀] or [▶].

Settings

- X·Y·Z : 0.01 ~ +300.000
- L* : 0.00 ~ +300.000
- a*·b* : -300.00 ~ +300.00
- L : 0.00 ~ +300.000
- a-b : -300.00 ~ +300.00
- Press the [Confirmation] key to confirm every time the setting of an item is changed.

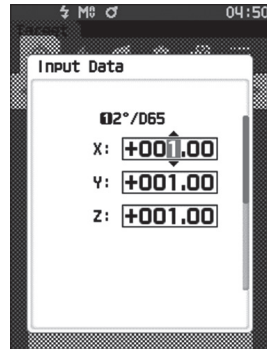

- 4 After all settings have been configured, use [▲] or [▼] to move the cursor to "OK", and then press the [Confirmation] key.

The setting is confirmed and the screen returns to the <Input Colorimetric data> screen.

- Notes** If you press the [ESC] key during setting, the setting value of the open screen is return to the value before the change.

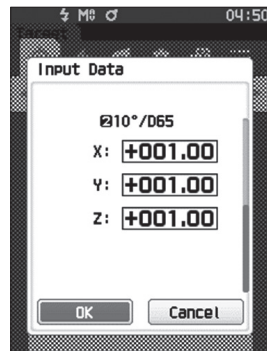

- 5 Press [ESC] to return to the <Input Colorimetric data> screen.

- Notes**
- If the selected target data number is already linked to the opacity-measured sample data, it cannot be registered. Delete the linked opacity data or change the selected target data number.
 - If you change Observer / Illuminant after entering input data Please note that the target data value is written as "----".

■ Default Data Settings

This instrument allows pass/fail judgment criteria to be set for individual target color data. Until such judgment criteria are set, the instrument is set with the default tolerance. Users can edit the tolerance that will be used as the judgment criteria as well as edit the warning level and the parametric coefficient default value.

Memo

- When a new target is measured, the default settings are initially applied.
- The default judgment criteria is set before judgment criteria for each target is set.
- Changing the default judgment criteria after the judgment criteria has already been set for individual target colors, the judgment criteria specified for these target colors will not be changed.
- The optional Color Data Software “SpectraMagic DX” allows for easy configuration and use of judgment criteria.

Operating Procedure

Start the procedure from the measurement screen.

- 1 Press [MENU], and then use [◀] or [▶] to display the <Setting> screen.
- 2 Use [▲] or [▼] to move the cursor to “Default data setup”, and then press the [Confirmation] key to display the <Default data setup> screen.

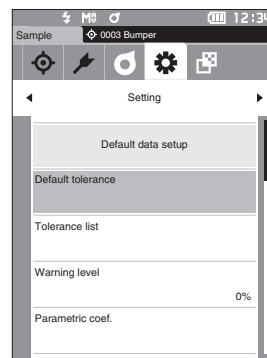
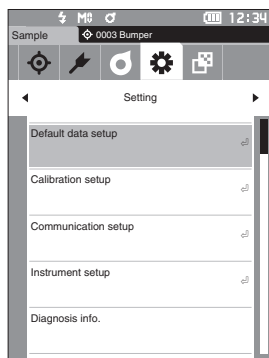

□ Tolerance List

Select the default index used for sample pass/fail judgment.

Operating Procedure

Start the procedure from the <Setting> - <Default data setup> screen.

1 Use [▲] or [▼] to move the cursor to “Tolerance list”, and then press the [Confirmation] key.

The available tolerances are displayed.

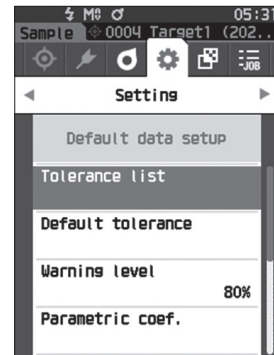

2 Use [▲] or [▼] to move the cursor to the item to set, and then press the [Confirmation] key.

- When the selected item is not currently checked, pressing the [Confirmation] key causes the item to be checked. When the selected item is currently checked, pressing the [Confirmation] key causes the item to be unchecked.
- Up to 14 indexes can be selected.



3 After all settings have been configured, use [▲] or [▼] to move the cursor to “OK”, and then press the [Confirmation] key.

The setting is confirmed and the screen returns to the <Default data setup> screen.

Pressing the [ESC] while configuring the settings will prevent the settings on the currently opened screen from being applied and revert all settings to the previous condition.

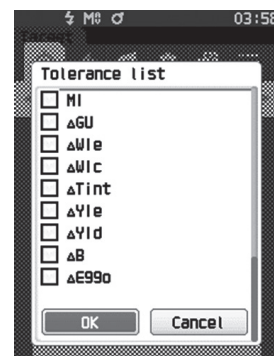

4 Press [ESC] to return to the <Default data setup> screen.

□ Default Tolerance Setting

- Memo** • The tolerance is set to the following values when the instrument is shipped from the factory.
 Lower limit: -1.00 Upper limit: 1.00
 $\Delta x, \Delta y$ Lower limit: -0.0100 Upper limit: 0.0100

Operating Procedure

Start the procedure from the <Setting> - <Default data setup> screen.

- 1 Move the cursor to "Default tolerance", and then press the [Confirmation] key.
The <Default tolerance> screen is displayed.
- 2 Use [▲] or [▼] to move the cursor to the item to be set, and then press the [Confirmation] key.
The <Edit tolerance> screen is displayed.
- 3 Use [▲]/[▼] or [◀]/[▶] to move the cursor to the item to set and press the [Confirmation] key to change the item.
 - When the selected item is not currently checked, pressing the [Confirmation] key causes the item to be checked, after which the setting value can be changed.
 - Press [◀] or [▶] to move the cursor to the setting value area. Pressing the [Confirmation] key causes the cursor to appear on the value. Press [▲] or [▼] to change the value. Move the cursor between the digits of the value by pressing [◀] or [▶].

Settings

- x / y : -0.2000 to 0.2000
- Color difference equation/MI : 0.00 to 20.00
- Other than the above : -20.00 to 20.00
- Press the [Confirmation] key to confirm every time the setting of an item is changed.

- 4 After all settings have been configured, use [▲] or [▼] to move the cursor to "OK", and then press the [Confirmation] key.

The setting is confirmed and the screen returns to the <Default data setup> screen.

If [ESC] is pressed during setup, the settings will not be changed and the screen will return to the <Default data setup> screen.

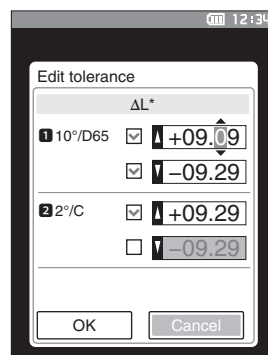
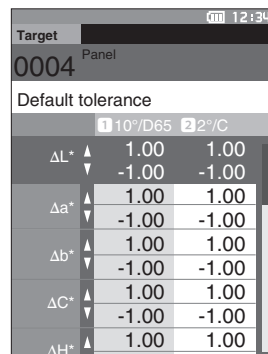
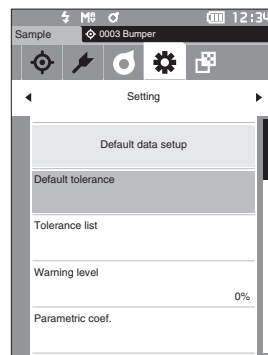

□ Warning Level Setting

Memo The warning level is set to “80%” when the instrument is shipped from the factory.

Operating Procedure

Start the procedure from the <Setting> - <Default data setup> screen.

- 1 Use [▲] or [▼] to move the cursor to “Warning level”, and then press the [Confirmation] key. The <Warning level> screen is displayed.

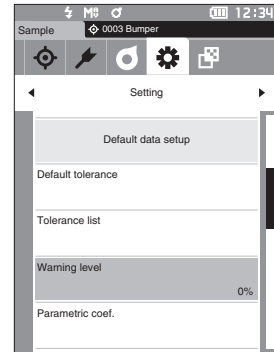

- 2 Use [▲] or [▼] to change the value.

Settings

- 000 to 100%

- 3 Press the [Confirmation] key after completing the changes.

The setting is confirmed and the screen returns to the <Default data setup> screen.

Notes If [ESC] is pressed during configuration, the settings will not be changed and the screen will return to the <Default data setup> screen.

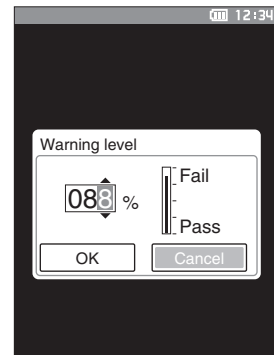

□ Parametric Coefficient Setting

Memo The parametric coef. is set to "1.00" when the instrument is shipped from the factory.

Operating Procedure

Start the procedure from the <Setting> - <Default data setup> screen.

- 1 Use [▲] or [▼] to move the cursor to "Parametric coef.", and then press the [Confirmation] key. The <Parametric coef.> screen is displayed.

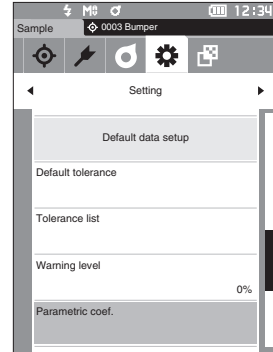

- 2 Use [▲] or [▼] to move the cursor to the item to be set, and then press the [Confirmation] key. The <Parametric coef.> edit screen is displayed.

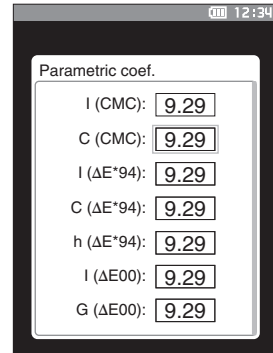

- 3 Use [▲] or [▼] to move the cursor to the item to set and press the [Confirmation] key to change the item.
 - Pressing the [Confirmation] key causes the cursor to appear on the value. Press [▲] or [▼] to change the value. Move the cursor between the digits of the value by pressing [◀] or [▶].

Settings

- 0.01 to 9.99
- Press the [Confirmation] key to confirm every time the setting of an item is changed.

- 4 After all settings have been configured, use [▲] or [▼] to move the cursor to "OK", and then press the [Confirmation] key. The setting is confirmed and the screen returns to the <Parametric coef.> screen.

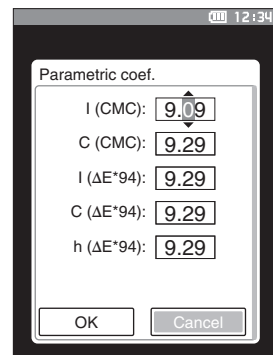

Notes If [ESC] is pressed during setup, the settings will not be changed and the screen will return to the <Parametric coef.> screen.

- 5 Press [ESC] to return to the <Default data setup> screen.

□ Set Group

Create groups for registering targets in advance.

Memo No group name is set when the instrument is shipped from the factory.

Operating Procedure

Start the procedure from the <Setting> - <Default data setup> screen.

- 1 Use [▲] or [▼] to move the cursor to “Set group”, and then press the [Confirmation] key.

The <Set group> screen is displayed.

The currently selected group numbers and names will be displayed in the upper table. The group is set by default when the target is measured.

The cursor will appear in the lower area with group numbers. Configure the group name.

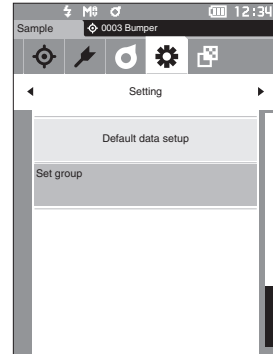

- 2 Use [▲] or [▼] to move the cursor to the group number of the group to edit. Numbers with blank names have not yet been set as a group. Assigning a name will register the number as a group. Users can also edit the names of existing groups.

Groups 01 through 50 can be set with up to 5 groups being available for registration.

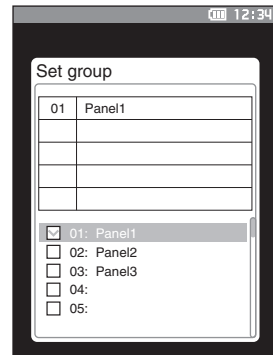

- 3 Check the box of the number to register to edit the name.

The <Edit name> screen is displayed.

Memo Checking the box registers the number to the table above, and when the target is measured, the number is automatically assigned to the appropriate group. To delete the information from the table, uncheck the box.



- 4 Use [▲]/[▼] or [◀]/[▶] to move the cursor between characters, and then press the [Confirmation] key.

- Up to 30 characters can be used.
- The selected character is displayed in the text box.

5 Repeat step 2 until the necessary characters have been entered.

- To delete the character to the left of the cursor in the text box, move the cursor to [**x**] and press the [**Confirmation**] key.

6 After inputting the characters, move the cursor to [Save] and press the [Confirmation] key.

The setting is confirmed and the screen returns to the <Set group> screen.

Memo If [**ESC**] is pressed during configuration, or if the cursor is moved to "Cancel" and the [**Confirmation**] key is pressed, the settings will not be changed and the screen will return to the <Set group> screen.

7 Move the cursor to [OK] (located below 50, which is at the very bottom) and press the [Confirmation] key.

The screen will return to the <Default data setup> screen. Be aware that failure to press the [**Confirmation**] key on [**OK**] will cancel all data. Proceed with caution.

Chapter 3

Setup

Measurement Condition Settings.....	81
Measurement Condition Settings.....	81
Measurement Option Settings	83
Display Condition Settings.....	89
Display Settings.....	93
Instrument Settings.....	98
Measurement Instrument Option Settings	98

Measurement Condition Settings

This instrument requires measurement condition settings (measurement mode, average count, observer/illuminant, and display) to be configured before measurement can be started.

■ Measurement Condition Settings

To set measurement conditions, select the setting from the <Measurement cond.> menu. The following four items can be specified as the measurement conditions:

- Measurement mode : Select the combination of colorimetry and gloss measurement.
- Measurement setup : Specify the number of measurements for automatic and manual averaging.
- Observer/Illuminant : Configure the two observers/illuminants.
- Display cond. : Configure the display type, color space, color difference equation, and 14 custom display items.

Operating Procedure

- 1 Press [MENU], and then use [◀] or [▶] to display the <Measurement cond.> menu screen.

Memo To return to the previous screen, press [MENU] or [ESC].

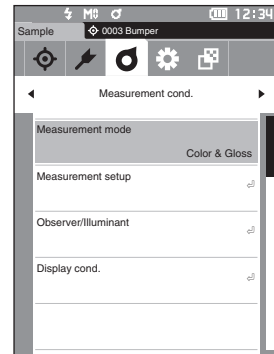

□ Measurement Mode

Select the combination of colorimetry and gloss measurement.

Memo The measurement mode is set to “Color & Gloss” when shipped from the factory.

Operating Procedure

Start the procedure from the <Measurement cond.> screen.

- 1 Use [▲] or [▼] to move the cursor to “Measurement mode”, and then press the [Confirmation] key. The <Measurement mode> screen is displayed.

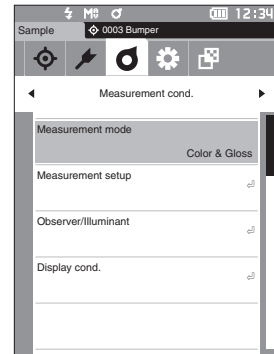

- 2 Use [▲] or [▼] to move the cursor to the desired measurement mode.

Selections

- Color & Gloss : Colorimetry + Gloss measurement
- Color only : Colorimetry
- Gloss only : Gloss measurement

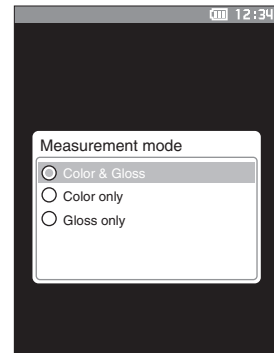

- 3 Press the [Confirmation] key to confirm, and then press [ESC].

The selection is confirmed and the screen returns to the previous screen.

Notes If [ESC] is pressed without pressing the [Confirmation] key, the settings will not be changed and the screen will return to the previous screen.

■ Measurement Option Settings

To set measurement options, select "Measurement setup" from the <Measurement cond.> menu screen. Select or specify the following items as the measurement options:

- Auto average (1 to 10) : Specify the number of measurements for auto averaging.
- Manual average (1 to 30) : Specify the number of measurements for manual averaging.
- Manual average option : Select the save method when performing manual averaging.
- SMC average option : Select the save method when performing SMC average measurement. (When SMC function is ON)
- SMC : Remove outliers beyond the threshold before performing measurement.
- SMC Threshold : Set the threshold for SMC measurement.
- SMC Times (3 to 10) : Set the number of measurements to perform when performing SMC measurement.

Operating Procedure

Start the procedure from the measurement screen.

- 1 Press [MENU], and then use [◀] or [▶] to display the <Measurement cond.> menu screen.

Memo To return to the previous screen, press [MENU] or [ESC].

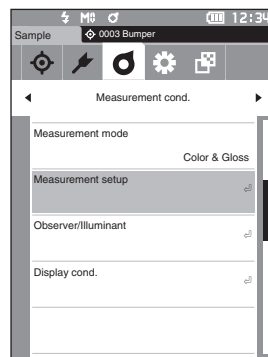

- 2 Use [▲] or [▼] to move the cursor to "Measurement setup", and then press the [Confirmation] key. The <Measurement setup> screen is displayed.

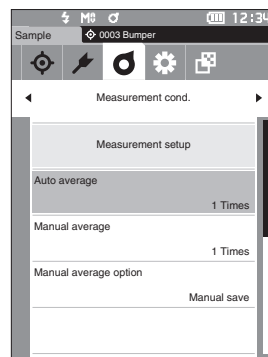

- 3 After setting the measurement conditions, press the [ESC] button to return to the previous screen.

□ Auto Average (1 to 10)

Specify the number of measurements for auto averaging. Every time the measurement button is pressed, the average of the data obtained from the specified number of continuous measurements is determined as sample data.

Memo "1 Times" is set as the number of measurements for automatic averaging when the instrument is shipped from the factory.

Operating Procedure

Start the procedure from the <Measurement cond.> - <Measurement setup> screen.

- 1 Use [▲] or [▼] to move the cursor to "Auto average", and then press the [Confirmation] key.

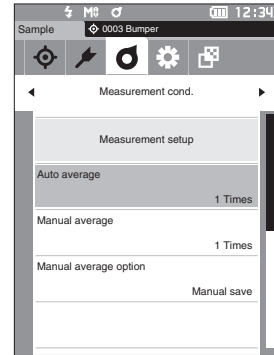

- 2 ▲ and ▼ will be displayed above and below the count in the count selection. Use [▲] or [▼] to specify a value.

Settings

- 1 to 10 times:
Specify the number of measurements, from 1 to 10, to perform when using auto averaging.

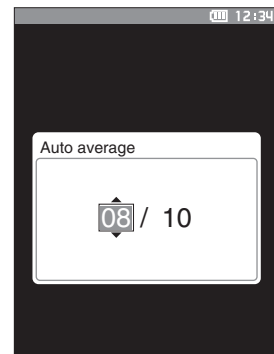

- 3 Press the [Confirmation] key.

The selection is confirmed and the screen returns to the <Measurement setup> screen.

Notes If [ESC] is pressed without pressing the [Confirmation] key, the settings will not be changed and the screen will return to the <Measurement setup> screen.

□ Manual Average (1 to 30)

Specify the number of measurements for manual averaging. The average of the data obtained from the measurements conducted by pressing the measurement button the specified number of times is determined as sample data.

Memo "1 Times" is set as the number of measurements for manual averaging when the instrument is shipped from the factory.

Operating Procedure

Start the procedure from the <Measurement cond.> - <Measurement setup> screen.

- 1 Use [▲] or [▼] to move the cursor to "Manual average", and then press the [Confirmation] key.

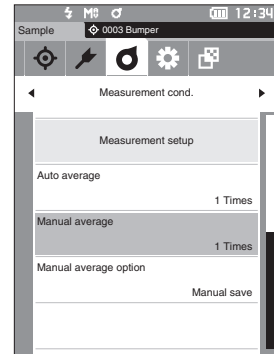

- 2 ▲ and ▼ will be displayed above and below the count in the count selection. Use [▲] or [▼] to specify a value.

Settings

- 1 to 30 times:
Specify the number of measurements, from 1 to 30, to perform when using manual averaging.

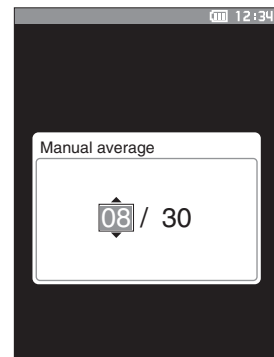

- 3 Press the [Confirmation] key.

The selection is confirmed and the screen returns to the <Measurement setup> screen.

Notes If [ESC] is pressed without pressing the [Confirmation] key, the settings will not be changed and the screen will return to the <Measurement setup> screen.

With manual average measurement, measurement is performed for the configured number of times the measurement button is pressed, and the average value of those measurements is saved as a single measurement. Selecting "Undo" after a measurement allows users to perform the previous measurement again.

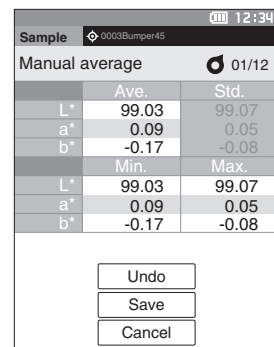

After the set number of measurements has been performed, the average can be saved by selecting "Save". To save the average automatically after the set number of measurements has been performed, select "Auto save" under <Measurement cond.> - <Measurement setup> - <Manual average option> screen.

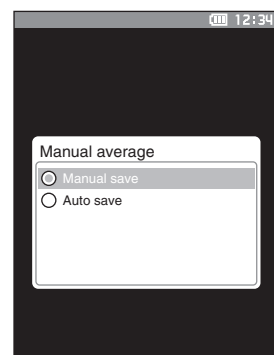

□ SMC Function (Outlier-Free Measurement)

The SMC (Statistical Measurement Control) function acquires the average using values that minimize variations in the measured data.

Memo SMC is set to "OFF" when the instrument is shipped from the factory.

Operating Procedure

Start the procedure from the <Measurement cond.> - <Measurement setup> screen.

- 1 Use [▲] or [▼] to move the cursor to "SMC", and then press the [Confirmation] key.

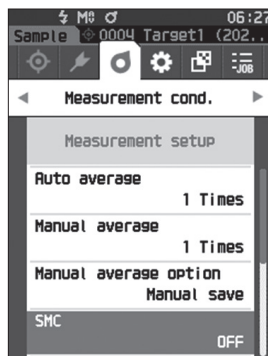

- 2 Use [▲] or [▼] to move the cursor to the item to set, and then press the [Confirmation] key.

Settings

- OFF
- ON

Notes Setting the SMC function to ON will disable manual averaging.



- 3 Press the [Confirmation] key.

The selection is confirmed and the screen returns to the <Measurement setup> screen.

Notes If [ESC] is pressed without pressing the [Confirmation] key, the settings will not be changed and the screen will return to the <Measurement setup> screen.

□ SMC Threshold

Sets the threshold to be used for the sample SMC function.

- Memo**
- The SMC threshold is set to “0.4” when the instrument is shipped from the factory.
 - For the threshold value, enter a value equivalent to the desired $\sigma\Delta E^*_{ab}$ for the average measurement data group (average data entries set on P.88).

Operating Procedure

Start the procedure from the <Measurement cond.> - <Measurement setup> screen.

- 1 Use [▲] or [▼] to move the cursor to “SMC Threshold”, and then press the [Confirmation] key.

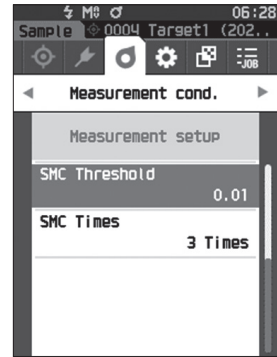

- 2 ▲ and ▼ are displayed above and below the number to be set.
Use [▲] or [▼] to specify a value.

Settings

- 0.01 to 9.99

- 3 Press the [Confirmation] key.
The selection is confirmed and the screen returns to the <Measurement setup> screen.

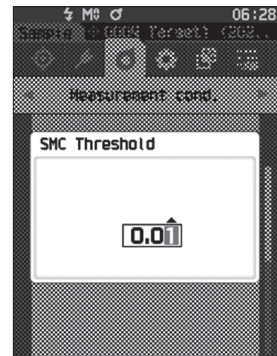

- Notes** If [ESC] is pressed without pressing the [Confirmation] key, the settings will not be changed and the screen will return to the <Measurement setup> screen.

□ SMC Times

Sets the threshold to be used for the sample SMC function.

Sets the number of measurements to perform when performing SMC average measurement. The average of the data obtained from the measurements conducted by pressing the measurement button several times is determined. The maximum number of measurements at this time is specified number in the setting + four times.

Memo "3" is set as the number of measurements for SMC averaging when the instrument is shipped from the factory.

Operating Procedure

Start the procedure from the <Measurement cond.> - <Measurement setup> screen.

- 1 Use [▲] or [▼] to move the cursor to "SMC Times", and then press the [Confirmation] key.

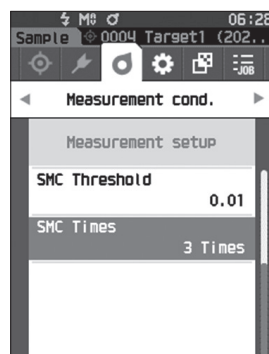

- 2 ▲ and ▼ will be displayed above and below the count in the count selection. Use [▲] or [▼] to specify a value.

Settings

- 3 to 10 times



- 3 Press the [Confirmation] key.

The selection is confirmed and the screen returns to the <Measurement setup> screen.

Notes If [ESC] is pressed without pressing the [Confirmation] key, the settings will not be changed and the screen will return to the <Measurement setup> screen.

With SMC average measurement, measurement is performed for the configured number of times the measurement button is pressed, and the average value of those measurements is saved as a single measurement. After the set number of measurements has been performed, the average can be saved by selecting "Save".

To save the average automatically after the set number of measurements has been performed, select "Auto save" under "Measurement cond." - "Measurement setup" - "SMC average option".

■ Display Condition Settings

To set display conditions, select "Observer/Illuminant" from the <Measurement cond.> menu screen.

The following two observer/illuminant settings can be configured for the display conditions.

- Observer/Illuminant 1: Select the observer/illuminant used to measure the colorimetric data.
- Observer/Illuminant 2: Select the secondary illuminant used for MI (metamerism index) calculation, etc.

Operating Procedure

Start the procedure from the measurement screen.

- 1 Press [MENU], and then use [◀] or [▶] to display the <Measurement cond.> menu screen.

Memo To return to the previous screen, press [MENU] or [ESC].

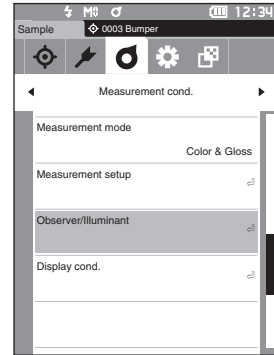

- 2 Use [▲] or [▼] to move the cursor to "Observer/Illuminant", and then press the [Confirmation] key. The <Observer/Illuminant> screen is displayed.

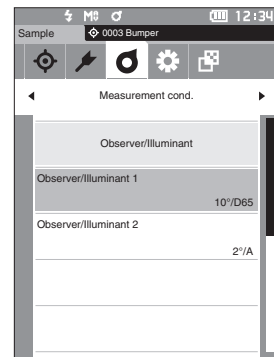

- 3 After setting the observer/illuminant, press [ESC] to return to the previous screen.

□ Observer/Illuminant 1

Select an observer angle of either 2° or 10° and the illuminant used to measure colorimetric data.

Memo Observer/Illuminant 1 is set to "10°/D65" when the instrument is shipped from the factory.

Operating Procedure

Start the procedure from the <Measurement cond.> - <Observer/Illuminant> screen.

- 1 Use [▲] or [▼] to move the cursor to "Observer/Illuminant 1", and then press the [Confirmation] key. The <Observer/Illuminant 1> screen is displayed. The scroll bar on the right of the screen shows that there are additional observer/illuminant settings that cannot fit on the screen.

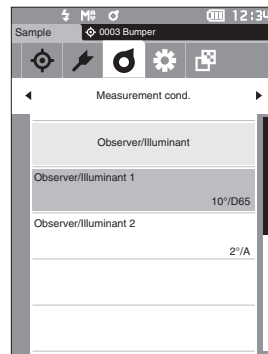

- 2 Use [▲] or [▼] to move the cursor to the desired item.

Moving the cursor past the top or bottom of the list will show additional observers/illuminants that cannot fit on the screen.

Settings

- 2°: 2° observer angle (CIE 1931)
 - 10°: 10° observer angle (CIE 1964)
- and
- A : Standard illuminant A (Incandescent lamp, Color temperature: 2856K)
 - C : Illuminant C (Daylight, Small relative value of spectral distribution in the ultraviolet region; Color temperature: 6774K)
 - D65 : Standard illuminant D₆₅ (Daylight, Color temperature: 6504K)
 - D50 : Standard illuminant D₅₀ (Daylight, Color temperature: 5003K)
 - ID65 : Indoor daylight illuminant ID65 (Daylight after passing through window glass, Color temperature: 6504K)
 - ID50 : Indoor daylight illuminant ID50 (Daylight after passing through window glass, Color temperature: 5003K)
 - F2 : Cool white (fluorescent lamp)
 - F6 : Cool white (fluorescent lamp)
 - F7 : Color rendering A daylight white (fluorescent lamp)
 - F8 : Color rendering AAA natural white (fluorescent lamp)
 - F10 : 3-band type natural white (fluorescent lamp)
 - F11 : 3-band type cool white (fluorescent lamp)
 - F12 : 3-band type warm white (fluorescent lamp)
 - User : User-configured illuminant

(* Optional Color Management Software SpectraMagic NX is required for setting user-configured illuminants. Note that the name configured in SpectraMagic NX will be displayed.)

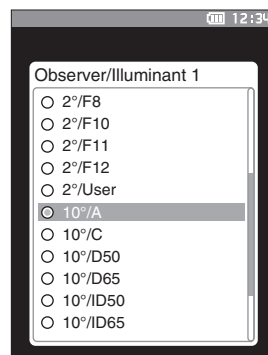

3 Press the [Confirmation] key.

The selection is confirmed and the screen returns to the <Observer/Illuminant> screen.

Notes If [ESC] is pressed without pressing the [Confirmation] key, the settings will not be changed and the screen will return to the <Observer/Illuminant> screen.

□ Observer/Illuminant 2

Select the secondary illuminant used for MI (metamerism index) calculation, etc.

Memo Observer/Illuminant 2 is set to "10°/F11" when the instrument is shipped from the factory.

Operating Procedure

Start the procedure from the <Measurement cond.> - <Observer/Illuminant> screen.

- 1 Use [▲] or [▼] to move the cursor to "Observer/Illuminant 2", and then press the [Confirmation] key. The <Observer/Illuminant 2> screen is displayed.

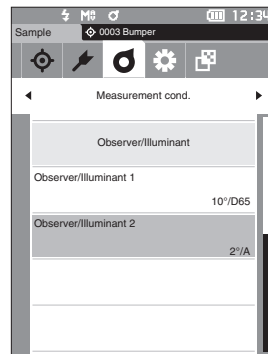

- 2 Use [▲] or [▼] to move the cursor to the desired item.

Settings

- The setting values are the same as those for "Observer/Illuminant 1" and "None".

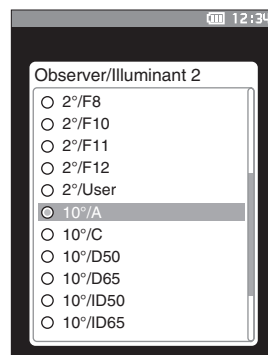

- 3 Press the [Confirmation] key. The selection is confirmed and the screen returns to the <Observer/Illuminant> screen.

Notes If [ESC] is pressed without pressing the [Confirmation] key, the settings will not be changed and the screen will return to the <Observer/Illuminant> screen.

■ Display Settings

To set display settings, select “Display cond.” from the <Measurement cond.> menu screen. The following four items (three items and 14 custom display items) can be specified as the display conditions.

- Display type : Select the screen to be displayed.
- Color space : Select the color space to be displayed.
- Equation : Select the color for which the color difference will be measured.
- Custom (01 to 14) : Select which options to add to the display, such as display color value, index, and color difference.

Operating Procedure

Start the procedure from the measurement screen.

- 1 Press [MENU], and then use [◀] or [▶] to display the <Measurement cond.> menu screen.

Memo To return to the previous screen, press [MENU] or [ESC].

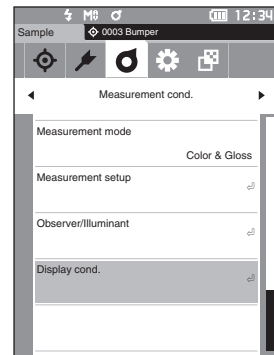

- 2 Use [▲] or [▼] to move the cursor to “Display cond.”, and then press the [Confirmation] key. The <Display cond.> screen is displayed.

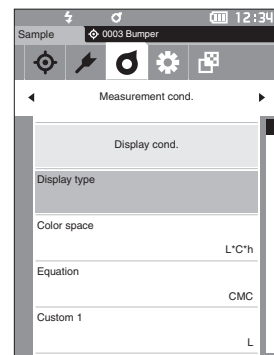

- 3 After setting the display conditions, press [ESC] to return to the previous screen.

□ Display Type

Configure the display type for the measurement results.

Memo All display types are selected when the instrument is shipped from the factory.

Operating Procedure

Start the procedure from the <Measurement cond.> - <Display cond.> screen.

- 1 Use [▲] or [▼] to move the cursor to “Display type”, and then press the [Confirmation] key. The <Display type> screen is displayed.

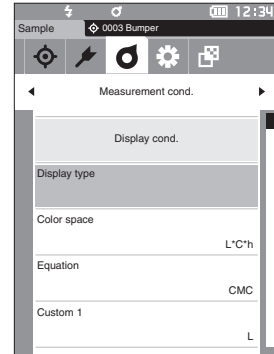

- 2 Use [▲] or [▼] to move the cursor to the desired display type, and then press the [Confirmation] key.

Selections

- Absolute value: Displays the absolute value of the colorimetric and the gloss value.
- Difference: Displays the color difference and gloss value difference against the target color. The measurement that failed the pass/fail judgment based on the tolerance will be highlighted in red.
- Abs. & Diff.: Displays the absolute value and the color difference and gloss value difference against the target color. The measurement that failed the pass/fail judgment based on the tolerance will be highlighted in red.
- Pass/Fail: Determines whether the color difference and gloss value difference related to the target are within the tolerance range set in advance. If within the tolerance, the judgment will be displayed as “Pass”. If even one difference is not within the tolerance, the judgment will be displayed as “Fail”.
- Custom: Displays the display color value and index set under “Custom” as the two illuminants.
- Abs. Graph: Displays a graph of the absolute value of the colorimetric and the gloss value.
- Diff. Graph: Displays a graph showing the color difference and gloss value difference against the target color.
- Spectral Graph: Displays a graph showing the spectral reflectance. The [Confirmation] key can be used to move the wavelength displaying the spectral reflectance value.

Memo A check mark means the item is selected.

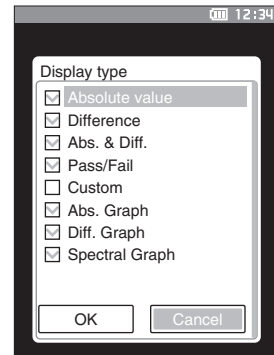

- 3 After all settings have been configured, use [▲] or [▼] to move the cursor to “OK”, and then press the [Confirmation] key.

The selection is confirmed and the screen returns to the previous screen.

Notes If [ESC] is pressed without pressing the [Confirmation] key, the settings will not be changed and the screen will return to the <Display cond.> screen.

□ Color Space

Select the color space to be used.

Memo The color space is set to "L*a*b*" when the instrument is shipped from the factory.

Operating Procedure

Start the procedure from the <Measurement cond.> - <Display cond.> screen.

- 1 Use [▲] or [▼] to move the cursor to "Color space", and then press the [Confirmation] key. The <Color space> screen is displayed.

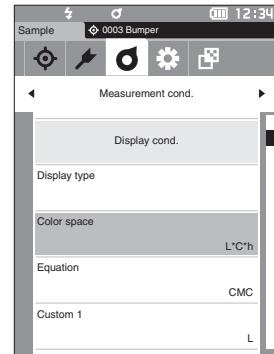

- 2 Use [▲] or [▼] to move the cursor to the desired color space.

Selections

- L*a*b*: L*a*b* color space
- L*C*h: L*C*h color space
- Hunter Lab: Hunter Lab color space
- Yxy: Yxy color space
- XYZ: XYZ color space
- Munsell (C): Munsell color space

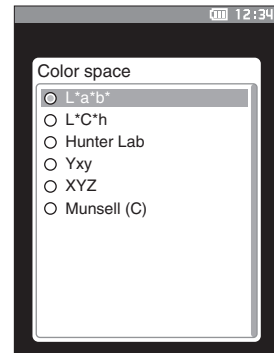

- 3 Press the [Confirmation] key to confirm, and then press [ESC].

The selection is confirmed and the screen returns to the previous screen.

Notes If [ESC] is pressed without pressing the [Confirmation] key, the settings will not be changed and the screen will return to the <Display cond.> screen.

□ Equation

Select the color difference equation to be used.

Memo The color difference equation is set to “ ΔE^*ab ” when the instrument is shipped from the factory.

Operating Procedure

Start the procedure from the <Measurement cond.> - <Display cond.> screen.

- 1 Use [\blacktriangle] or [\blacktriangledown] to move the cursor to “Equation”, and then press the [Confirmation] key. The <Equation> screen is displayed.

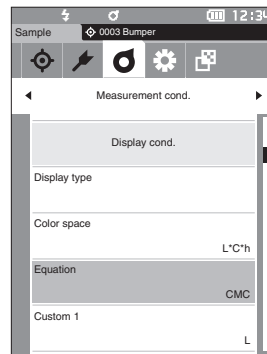

- 2 Use [\blacktriangle] or [\blacktriangledown] to move the cursor to the desired equation.

Selections

- ΔE^*ab : ΔE^*ab (CIE 1976) color difference equation
- CMC: CMC color difference equation; Parameters can be changed.
- ΔE^*1994 : ΔE^*94 (CIE 1994) color difference equation; Parameters can be changed.
- $\Delta E2000$: $\Delta E00$ (CIE DE2000) color difference equation; Parameters can be changed.
- ΔE (Hunter): Hunter Lab color difference equation
- $\Delta E99o$: $\Delta E99o$ (DIN99o) color difference equation

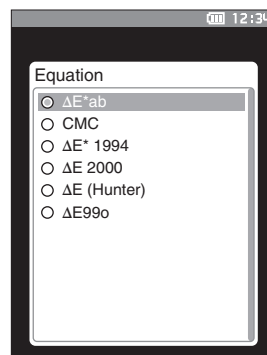

- 3 Press the [Confirmation] key to confirm, and then press [ESC].

The selection is confirmed and the screen returns to the previous screen.

Notes If [ESC] is pressed without pressing the [Confirmation] key, the settings will not be changed and the screen will return to the <Display cond.> screen.

□ Custom

Select the items, including the color space, color difference equation, or index, to be used.

Up to 14 items (Custom 01 to Custom 14) to be displayed can be set. This selection screen is available when the user index has been set with the optional Color Management Software SpectraMagic NX (CM-S100w) in advance. In this case, the name configured in SpectraMagic NX will be displayed.

Operating Procedure

Start the procedure from the <Measurement cond.> - <Display cond.> screen.

1 Use [▲] or [▼] to move the cursor to “Custom xx (01 to 14)”, and then press the [Confirmation] key.

The screen for selecting the display items is displayed.

The scroll bar at the right on the screen shows that there are additional display items that cannot fit on the screen.

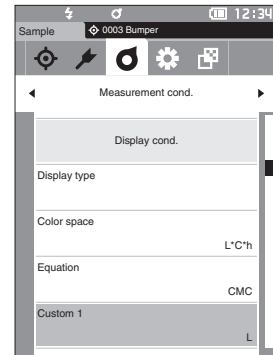

2 Use [▲] or [▼] to move the cursor to the desired display item.

Moving the cursor past the top or bottom of the list will show additional display items that cannot fit on the screen.

Settings

The following indexes as well as display color values and color differences for color spaces that can be configured under color space and color difference equation can be set.

- WI ASTM E313-73 and ΔWI : Whiteness index (ASTM E313-73)
- WI CIE and ΔWI : Whiteness index (CIE)
- Tint CIE and $\Delta Tint$: Tint (CIE)
- YI ASTM E313-73 and ΔYI : Yellowness index (ASTM E313-73)
- YI ASTM D1925 and ΔYI : Yellowness index (ASTM D1925)
- ISO Brightness and ΔB : Brightness
- $\Delta E99o$: $\Delta E99o$ (DIN99o) color difference equation
- MI : Metamerism
- GU and ΔGU : Gloss index
- None
- UE1 to UE3 : User equations
- UC1 to UC3

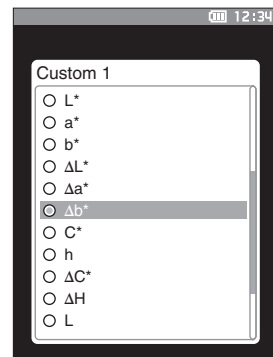

3 Press the [Confirmation] key to confirm, and then press [ESC].

The selection is confirmed and the screen returns to the previous screen.

Notes If [ESC] is pressed without pressing the [Confirmation] key, the settings will not be changed and the screen will return to the <Display cond.> screen.

Instrument Settings

■ Measurement Instrument Option Settings

To set measurement instrument options, select “Instrument setup” from the <Setting> screen.

Operating Procedure

Start the procedure from the measurement screen.

- 1 Press [MENU], and then use [◀] or [▶] to display the <Setting> screen.

Memo To return to the previous screen, press [MENU] or [ESC].

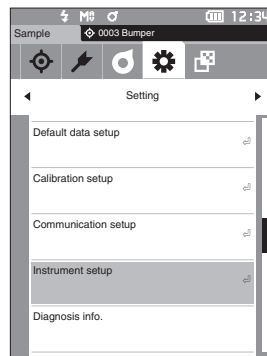

- 2 Use [▲] or [▼] to move the cursor to “Instrument setup”, and then press the [Confirmation] key. The <Instrument setup> screen is displayed.

- 3 After setting the measurement instrument conditions, press the [ESC] button to return to the previous screen.

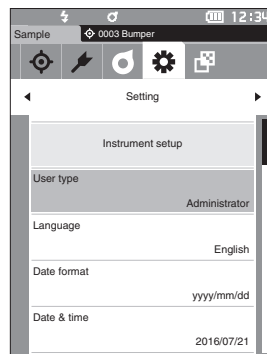

□ User Type

Settings can be protected for each user.

Memo The user type is set to “Administrator” when the instrument is shipped from the factory.

Operating Procedure

Start the procedure from the <Setting> - <Instrument setup> screen.

- 1 Use [▲] or [▼] to move the cursor to “User type”, and then press the [Confirmation] key. The <User type> setting screen is displayed.

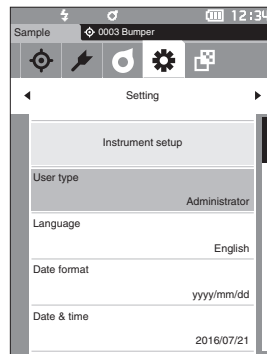

- 2 Use [▲] or [▼] to move the cursor and select the user type.

Selections

- Administrator: All settings can be changed.
- Worker: Some settings cannot be changed.

Memo The operations that workers can perform are as follows

- “Sample” browsing/measurement/printing/deletion
- “Target” browsing/printing
- Calibration
- Instrument info. displaying
- Change user type

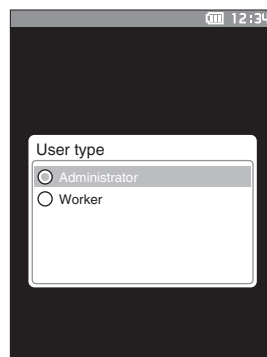

Notes Settings for operations that workers can perform can be changed using the CM-CT1 software included as a standard accessory.

Memo It is possible to set a password for changing workers to administrators. For details, read P.107 “Password Setting”.

- 3 Press the [Confirmation] key to confirm, and then press [ESC]. The selection is confirmed and the screen returns to the <Instrument setup> screen.

Notes If [ESC] is pressed without pressing the [Confirmation] key, the settings will not be changed and the screen will return to the <Instrument setup> screen.

□ Display Language Settings

This instrument allows the display language to be set.

To display the language setting screen, press and hold [MENU] while starting up the instrument.

Memo The language is set to “English” when the instrument is shipped from the factory.

Notes When the backup battery of the instrument has gone dead, the display language is reset to “English”.

Operating Procedure

Start the procedure from the <Setting> - <Instrument setup> screen.

- 1 Use [▲] or [▼] to move the cursor to “Language”, and then press the [Confirmation] key.

The <Language> screen is displayed.

The scroll bar at the right on the <Language> screen shows that there are additional language settings that cannot fit on the screen.

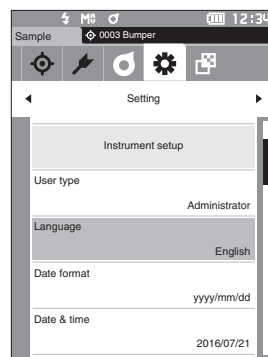

- 2 Use [▲] or [▼] to move the cursor to the desired language.

Moving the cursor past the top or bottom of the list will show additional language settings that cannot fit on the screen.

Settings

- English
- Japanese
- German
- French
- Spanish
- Italian
- Chinese
- Portuguese
- Polish
- Russian
- Turkish

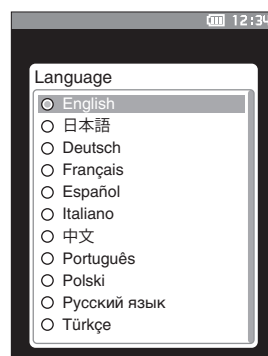

- 3 Press the [Confirmation] key to confirm, and then press [ESC].

The selection is confirmed and the screen returns to the <Instrument setup> screen.

Notes If [ESC] is pressed without pressing the [Confirmation] key, the settings will not be changed and the screen will return to the <Instrument setup> screen.

□ Setting the Date Format

The format of the date displayed on the screen can be changed.

Memo The date format is set to “yyyy/mm/dd” when the instrument is shipped from the factory.

Operating Procedure

Start the procedure from the <Setting> - <Instrument setup> screen.

- 1 Use [▲] or [▼] to move the cursor to “Date format”, and then press the [Confirmation] key.
The <Date format> screen is displayed.

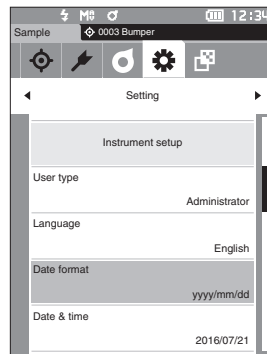

- 2 Use [▲] or [▼] to move the cursor to the desired date format.

Settings

- yyyy/mm/dd : The date is displayed in year/month/day order.
- mm/dd/yyyy : Display the date in the format of month/day/year.
- dd/mm/yyyy : Display the date in the format of day/month/year.

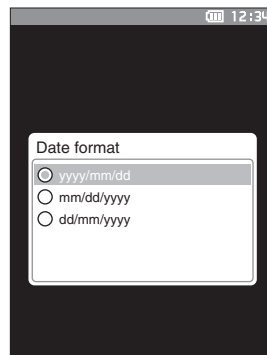

- 3 Press the [Confirmation] key to confirm, and then press [ESC].

The selection is confirmed and the screen returns to the <Instrument setup> screen.

Notes If [ESC] is pressed without pressing the [Confirmation] key, the settings will not be changed and the screen will return to the <Instrument setup> screen.

□ Setting the Clock

This instrument has a built-in clock to record the date and time of measurement. Because the date and time have been set at the factory, there is no need to change these settings under normal conditions. If necessary, however, the date and time settings may be configured.

Operating Procedure

Start the procedure from the <Setting> - <Instrument setup> screen.

- 1 Use [▲] or [▼] to move the cursor to “Date & time”, and then press the [Confirmation] key.

The <Date & time> setting screen is displayed.

- 2 Use [▲] or [▼] to move the cursor to the item to be set, and then press the [Confirmation] key.

The cursor color turns to blue and ▲ and ▼ are displayed above and below the cursor.

- 3 Use [▲] or [▼] to change the value.

Settings

- Year : 2000–2099
- Month : 1 to 12
- Day : 1 to 28, 29, 30 and 31 (varies with selected month/year)
- Hour : 0 to 23
- Minute : 0 to 59
- Second : 0 to 59
- The value increases/decreases by one with each button press.
- Holding down [▲] or [▼] increases/decreases the value by one continuously.
- Use [◀] or [▶] to move between digits.

- 4 Press the [Confirmation] key.

The setting is confirmed.

Notes If [ESC] is pressed without pressing the [Confirmation] key, the settings will not be changed.

- 5 Repeat steps 2 to 4 for each of the date (Year/ Month/Day) and time (Hour : Minute : Second) parameters.

- 6 After all settings have been configured, use [▲] or [▼] to move the cursor to “OK”, and then press the [Confirmation] key.

The selection is confirmed and the screen returns to the <Instrument setup> screen.

Notes If [ESC] is pressed without pressing the [Confirmation] key, the settings will not be changed and the screen will return to the <Instrument setup> screen.

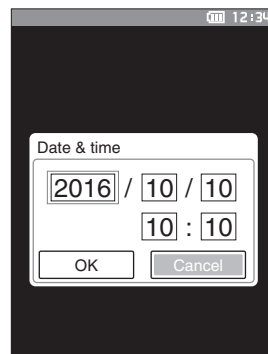
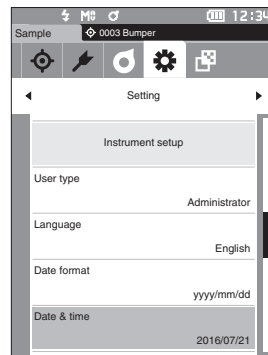

□ Screen Brightness

The brightness of the LCD can be set in five levels. Selecting a darker level is effective for power saving.

Memo Screen brightness is set to “3 (Standard)” when the instrument is shipped from the factory.

Operating Procedure

Start the procedure from the <Setting> - <Instrument setup> screen.

- 1 Use [▲] or [▼] to move the cursor to “Brightness”, and then press the [Confirmation] key. The <Brightness> setting screen is displayed.

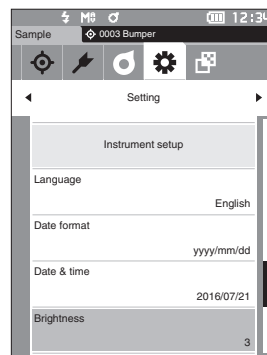

- 2 Use [▲] or [▼] to move the cursor to the desired brightness.

Settings

- 5 (Light)
- 4
- 3 (Standard)
- 2
- 1 (Dark)

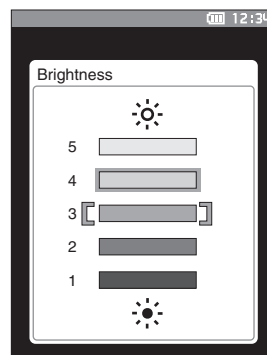

- 3 Press the [Confirmation] key to confirm, and then press [ESC]. The selection is confirmed and the screen returns to the <Instrument setup> screen.

Notes If [ESC] is pressed without pressing the [Confirmation] key, the settings will not be changed and the screen will return to the <Instrument setup> screen.

□ LCD Screen Display Orientation

Depending on how the instrument is held, the display may be more visible upside-down. This function allows the display to be set to a different orientation in such instances.

Operating Procedure

Start the procedure from the <Setting> - <Instrument setup> screen.

- 1 Use [▲] or [▼] to move the cursor to “Direction”, and then press the [Confirmation] key.

The display will flip upside-down and return to the <Instrument setup> screen.

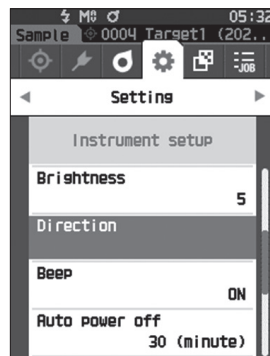

□ Buzzer

Operation sounds can be set to ON or OFF.

Memo The buzzer is set to “ON” when the instrument is shipped from the factory.

Operating Procedure

Start the procedure from the <Setting> - <Instrument setup> screen.

- 1 Use [▲] or [▼] to move the cursor to “Beep”, and then press the [Confirmation] key.
The <Beep> setting screen is displayed.

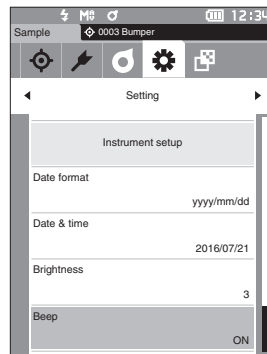

- 2 Use [▲] or [▼] to move the cursor to ON or OFF.

Settings

- OFF
- ON (Standard)



- 3 Press the [Confirmation] key to confirm, and then press [ESC].

The selection is confirmed and the screen returns to the <Instrument setup> screen.

Notes If [ESC] is pressed without pressing the [Confirmation] key, the settings will not be changed and the screen will return to the <Instrument setup> screen.

□ Auto Power Off

The amount of time before switching the power off can be set.

Memo Auto power off is set to “0 (minute)” (no auto power off) when the instrument is shipped from the factory.

Operating Procedure

Start the procedure from the <Setting> - <Instrument setup> screen.

- 1 Use [▲] or [▼] to move the cursor to “Auto power off”, and then press the [Confirmation] key.

The <Auto power off> setting screen is displayed.

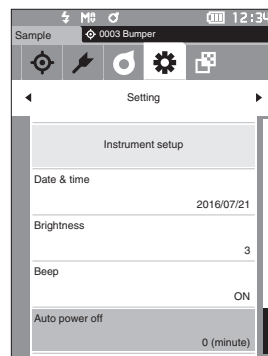

- 2 Use [▲] or [▼] to change the value.
Settings

- 00 to 60 minutes

Memo If set to “00”, no auto power off.

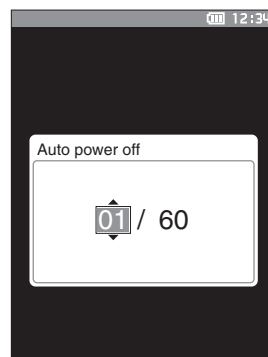

- 3 Press the [Confirmation] key to confirm, and then press [ESC].

The selection is confirmed, and the screen returns to the <Instrument setup> screen.

Notes If [ESC] is pressed without pressing the [Confirmation] key, the settings will not be changed, and the screen will return to the <Instrument setup> screen.

□ Password Setting

The password required for changing the user type from a worker to an administrator can be configured in the instrument setup.

Operating Procedure

Start the procedure from the <Setting> - <Instrument setup> screen.

- 1 Use [▲] or [▼] to move the cursor to “Password Setting”, and then press the [Confirmation] key. The <Password Setting> screen is displayed.

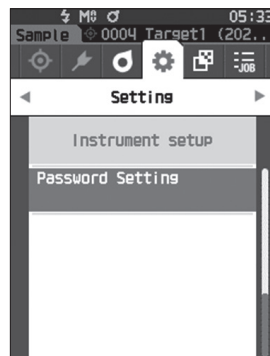

- 2 Use [◀]/[▶] or [▲]/[▼] to set the password. Settings
8 digits (Initial value “00000000”: No set password)

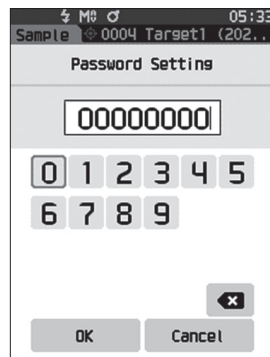

- 3 Press the [Confirmation] key. The selection is confirmed and the screen returns to the <Measurement setup> screen.

Notes If [ESC] is pressed without pressing the [Confirmation] key, the settings will not be changed and the screen will return to the <Measurement setup> screen.

Chapter 4

Other Functions

Connecting to an External Device	109
◆ Connecting to a Personal Computer	109
Connecting via USB Cable.....	110
Connecting via Bluetooth	111
Communication Setup.....	112
◆ Connecting to a Printer/Barcode Reader	115
Instrument Preparation	116
System Settings.....	121
Calibration Setup.....	121
Displaying Diagnosis Information	125
Displaying the Instrument Information	126
JOB Function	127

Connecting to an External Device

This instrument includes a USB connection terminal and a Bluetooth function (when the optional Bluetooth module is attached). The supplied USB cable (IF-A26) can be used to connect the instrument to a PC, or the Bluetooth communication function can be used to connect the instrument to a PC or a printer, allowing for data communication and printing.

Notes When the instrument is exposed to strong external static electricity or is affected by ambient interference during communication with an external device, the communication may be interrupted. In this case, turn the power OFF and then turn it ON again.

◆ Connecting to a Personal Computer

There are two methods for connecting the instrument to a PC: connecting using the USB cable or via the Bluetooth function.

Notes

- To use the instrument's Bluetooth function to connect to a PC with Bluetooth communication capabilities, the CM-A189 Bluetooth module must be correctly connected to the instrument and a Bluetooth communication channel must be opened through the PC's utilities function.
- When connections using the USB cable and using Bluetooth communication are established, priority will be given to the connection using the USB cable.

Memo

- When connected to a PC, the wireless communication or the wired communication mark is displayed on the LCD screen (refer to page 20 "Status Bar"), and the measurement button and control keys on the instrument are disabled.
- If a command to enable the measuring button is sent from the PC, measurement will be possible by pressing the measurement button on the instrument. Note that, at this time, the measurement data is transferred to the PC without being stored in the instrument memory.
- To connect the instrument to a PC, use of software that enables connection and operation of the instrument is recommended.

● Connecting via USB Cable

Connect the instrument to a PC with the supplied USB cable IF-A26 (2 m).

Notes

- To connect the instrument to a PC, the dedicated USB driver must be installed. The necessary drivers will be installed automatically. To install the drivers manually, use the drivers included with the software (such as the optional SpectraMagic DX software).
- The instrument can be powered through the USB cable. (The battery must always be installed.)
- When power is being supplied via USB, the charging lamp on the instrument's panel will light up orange while charging. When charging is complete, the lamp will turn green.
- Make sure that the USB connector plug is oriented correctly and connected securely.
- When connecting/disconnecting the USB cable, be sure to hold the connector plug. Do not pull on or forcibly bend the cable. Otherwise, wire breakage may result.
- Make sure that the cable has sufficient length. Putting tension on the cable may cause connection failure or wire breakage.
- Firmly push in the USB cable connector that matches the shape of the port (connection terminal) until it can go in no further.

Memo

The USB communication port of the instrument conforms to USB 2.0.

Operating Procedure

- 1 Open the connector's protective cover, and connect the USB cable mini plug to the USB port on the instrument.**

- ◆ Fully insert the connector and ensure the connection is secure.

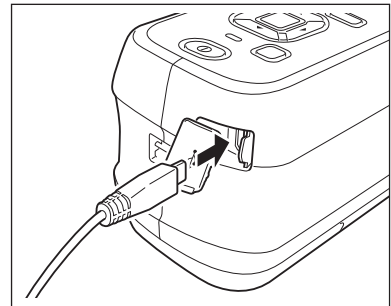

- 2 Connect the A connector of the USB cable to the USB port on the PC.**

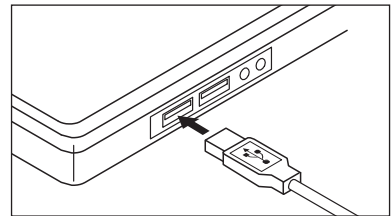

- 3 Turn the instrument power ON.**

- ◆ When installation of the USB driver is prompted, specify the USB driver included with the software to complete the installation.

● Connecting via Bluetooth

Connect the instrument to a PC with Bluetooth communication functionality using the optional Bluetooth module.

Notes

- The instrument's Bluetooth function enables data communication with a connected PC and printing from a Bluetooth computer. Connecting to both a PC and a printer/scanner at the same time, however, is not possible.
- A simultaneous connection via the USB cable and the Bluetooth function is not possible. Should both connections be established at the same time, priority will be given to the connection via USB cable.

Memo

To connect the instrument to a PC via the Bluetooth function, appropriate preparations for Bluetooth communication must be performed in advance for both the instrument and the printer.

○ Instrument Preparation

Attach the optional Bluetooth module (CM-A219).

Turn ON the instrument's Bluetooth function and configure the PIN code on the instrument as required.

• Connecting the Bluetooth Module

Operating Procedure

1 Slide open the instrument's battery compartment cover and attach the Bluetooth module.

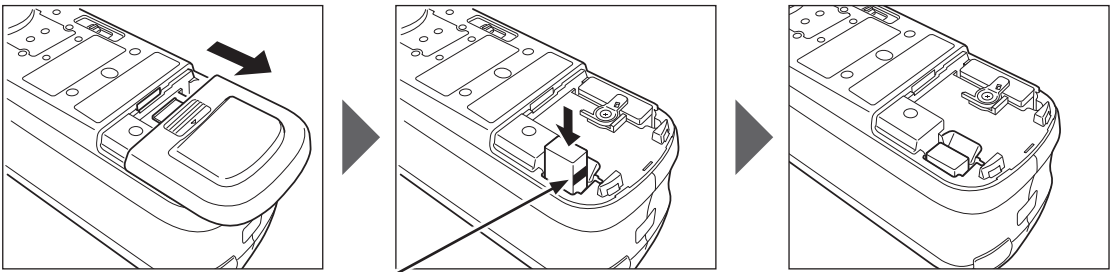

A line can be seen on the side of the module.

Notes

When inserting the Bluetooth module, please note that the module will be slightly loose. Pushing forcibly on the module may damage the connector if the module and the connector on the instrument are not aligned correctly. The module and the connector on the instrument will be aligned correctly if the line on the side of the module is no longer visible when the module is dropped into the slot. Push the module in from this position until it clicks (approx. 1 mm).

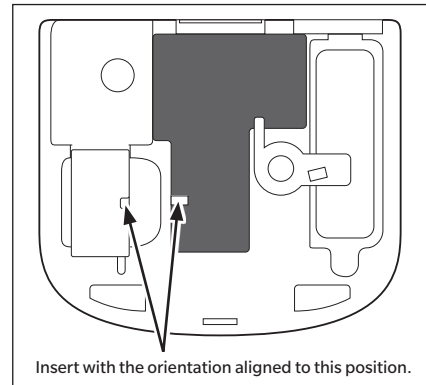

2 Slide the battery compartment cover to close it.

■ Communication Setup

Turn ON the Bluetooth function and configure the meter PIN code.

Operating Procedure

Start the procedure from the measurement screen.

- 1 Press [MENU], and then use [◀] or [▶] to display the <Setting> screen.

Memo To return to the previous screen, press [MENU] or [ESC].

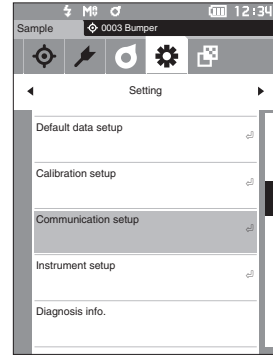

- 2 Use [▲] or [▼] to move the cursor to "Communication setup", and then press the [Confirmation] key. The <Communication setup> screen is displayed.

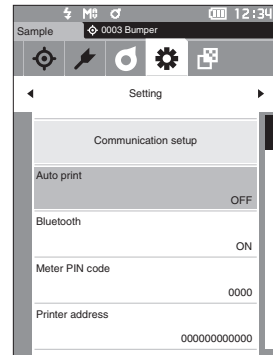

□ Turning Bluetooth ON

Memo The Bluetooth function is set to "OFF" when the instrument is shipped from the factory.

Operating Procedure

Start the procedure from the <Setting> - <Communication setup> screen.

- 1 Use [▲] or [▼] to move the cursor to "Bluetooth", and then press the [Confirmation] key. The <Bluetooth> screen is displayed.

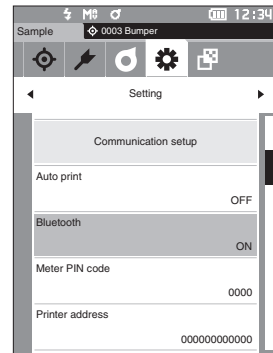

2 Use [▲] or [▼] to move the cursor to “ON”, and then press the [Confirmation] key.

The instrument’s Bluetooth function is turned ON and the display will return to the <Communication setup> screen. The Bluetooth icon will be displayed in the status bar. To configure the Bluetooth PIN code, go to step 3 to continue.

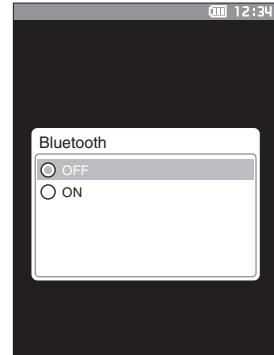

3 Use [▲] or [▼] to move the cursor to “Meter PIN code”, and then press the [Confirmation] key.

The <Meter PIN code> screen is displayed.

- The initial value of the PIN code is “0000”.

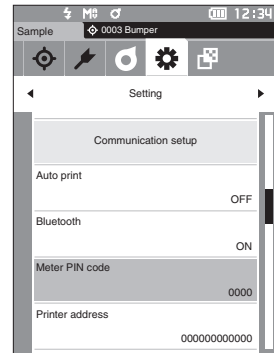

4 ▲ and ▼ will be displayed above and below the PIN. Use [▲] or [▼] to specify a value. Use [◀] or [▶] to move between digits.

- The personal identification number (PIN) should consist of between four and eight numbers (0 to 9).

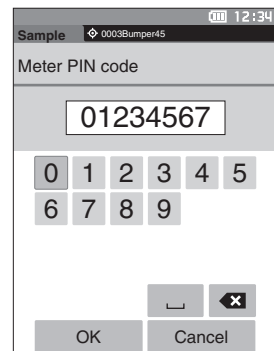

5 After inputting the value, press the [Confirmation] key.

The display will return to the <Communication setup> screen.

○ PC Connection

With the PC as a host, a connection to the instrument can be established using Bluetooth communication.

Operating Procedure

- 1 Verify that the instrument power has been turned ON.**
- 2 Verify that the Bluetooth function on the instrument has been turned ON. Also make sure the Bluetooth function is not being used to connect to a printer and that the USB cable is not being used to connect to the PC.**
- 3 Start the Bluetooth utility on the PC.**
- 4 Search for nearby Bluetooth devices, and select "CM-A219" from the list of displayed devices.**
- 5 Enter the PIN code for the instrument (refer to step 4 on page 113) on the PC.**
- 6 Open the Bluetooth serial port to connections.**
Once the connection has been established, the remote icon will be displayed in the status bar on the instrument.

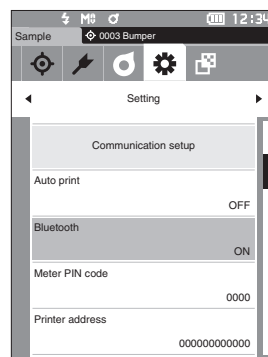

◆ Connecting to a Printer/Barcode Reader

Connecting the instrument to a printer or barcode scanner via the Bluetooth function enables printing of various data such as measurement results or scanning of names for data to save to the instrument.

Notes

- **With the CM-A219 Bluetooth module installed, the Bluetooth function of this instrument enables data communication to a PC, data printing to the CM-A234 Bluetooth printer, and reading of data names from a barcode scanner. However, connecting to both the Bluetooth module and a PC is not possible.**
- **Using a printer other than the CM-A234 optional Bluetooth printer may result in incorrect operation.**
- **Printing is possible at distances up to 10 m, but the distance at which operation can be performed properly depends on the wireless environment around the device.**
- **The optional accessory Bluetooth printer CM-A234 can only print text. Spectral graphs, color difference graphs, and other graphics displayed on the instrument cannot be printed.**

Memo

- To connect the instrument to a printer or barcode scanner via the Bluetooth function, appropriate preparations for Bluetooth communication must be performed in advance for both the instrument and the printer or barcode reader.
- Bluetooth communication with the instrument supports the Serial Port Profile (SPP).
Note that some printers and barcode readers may not operate correctly even if SPP is supported. Use equipment recommended by a KONICA MINOLTA-authorized service facility.

○ Printer/Barcode Reader Preparation

The following section describes the preparations required for ensuring that the instrument recognizes the separately available Bluetooth printer (CM-A234) or a barcode reader as a Bluetooth device.

Notes

This section describes general procedures. For more information, please refer to the instruction manuals included with the Bluetooth printer (CM-A234) and the barcode reader.

Operating Procedure

1 Ensure use of the Bluetooth printer / barcode reader is possible.

- ◆ Verify that the printer/reader communication mode is set to Bluetooth. In addition, charge batteries and load printer paper as required.

2 Verify the Bluetooth address and PIN code of the printer/reader.

○ Instrument Preparation

Connecting the Bluetooth module to the instrument, and turn ON the instrument's Bluetooth function. (Refer to page 111.)

Notes Until the instrument's Bluetooth function is turned ON, registration and automatic printing configuration of the Bluetooth printer/reader is not possible.

□ Registering a Bluetooth Address

Operating Procedure

Start the procedure from the <Setting> - <Communication setup> screen.

- 1 Use [▲] or [▼] to move the cursor to "Printer address" / "Scanner address", and then press the [Confirmation] key.

The "Printer address" / "Scanner address" screen is displayed.

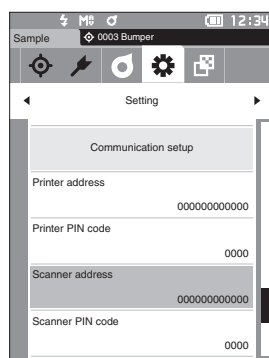
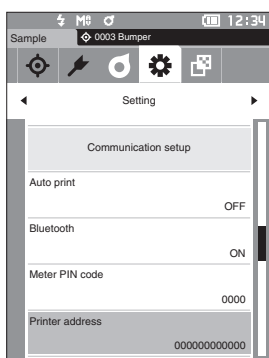

- 2 Enter the address of the Bluetooth device to be connected.

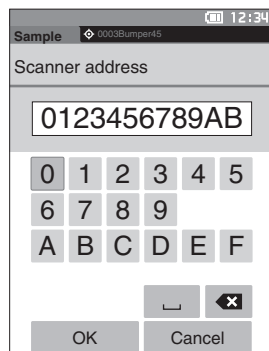

- 3 After inputting the characters, move the cursor to [OK] and press the [Confirmation] key.

The printer/reader will be registered as an I/O device for the instrument, and the display will return to the <Communication setup> screen.

Memo If [ESC] is pressed during configuration, or if the cursor is moved to "Cancel" and the [Confirmation] key is pressed, the settings will not be changed and the screen will return to the <Communication setup> screen.

□ PIN Code Configuration

Enter the PIN set for the printer/scanner (already confirmed).

Operating Procedure

Start the procedure from the <Setting> - <Communication setup> screen.

1 Use [▲] or [▼] to move the cursor to “Printer PIN code” or “Scanner PIN code”, and then press the [Confirmation] key.

- The initial value of the PIN code is “0000”.

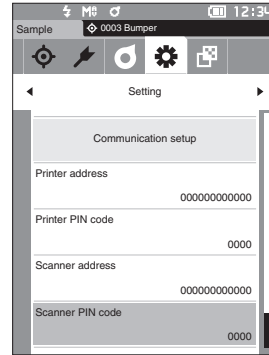
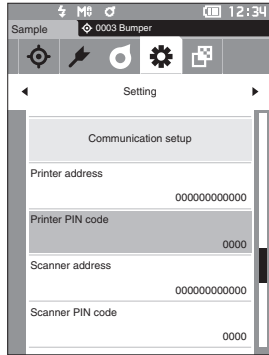

2 ▲ and ▼ will be displayed above and below the PIN. Use [▲] or [▼] to specify a value. Use [◀] or [▶] to move between digits.

- The personal identification number (PIN) should consist of between four and eight numbers (0 to 9).

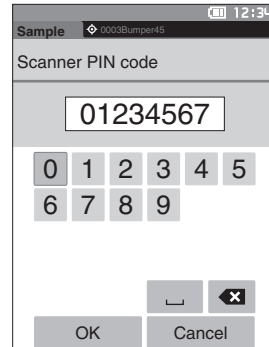
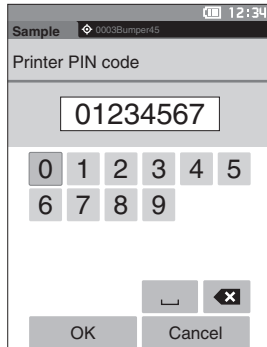

3 After inputting the numbers, move the cursor to [OK] and press the [Confirmation] key.

The printer/reader will be connectable as an I/O device for the instrument, and the display will return to the <Communication setup> screen.

Memo If [ESC] is pressed during configuration, or if the cursor is moved to “Cancel” and the [Confirmation] key is pressed, the settings will not be changed and the screen will return to the <Communication setup> screen.

□ Printing Data

Print the sample data or target data with the printer.

- Notes**
- The instrument must be connected to the printer in advance.
 - The optional accessory Bluetooth printer CM-A234 can only print text. Spectral graphs, color difference graphs, and other graphics displayed on the instrument cannot be printed.

Operating Procedure

Start the procedure from the <Target> or <Sample> screen.

- 1 To print the target and sample display, press the [MENU] key with the data to be printed displayed. The <Target menu> screen or the <Sample menu> screen will be displayed.

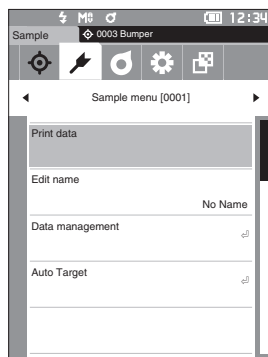
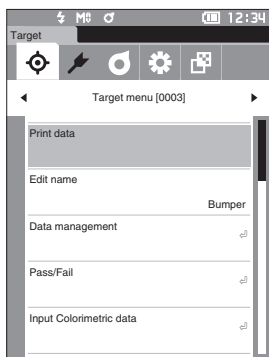

- 2 Use [▲] or [▼] to move the cursor to "Print data".

Press the [Confirmation] key and print the data from the connected printer.

- When the printing is complete, the screen returns to the <Target> / <Sample> screen.

□ Auto Print

Measurement results can be automatically printed for every measurement.

- Notes**
- The instrument must be connected to the printer in advance.
 - The optional accessory Bluetooth printer CM-A234 can only print text. Spectral graphs, color difference graphs, and other graphics displayed on the instrument cannot be printed.

Memo Auto print is set to “OFF” when the instrument is shipped from the factory.

Operating Procedure

Start the procedure from the <Setting> - <Communication setup> screen.

- 1 Use [▲] or [▼] to move the cursor to “Auto print”, and then press the [Confirmation] key. The <Auto print> screen is displayed.
- 2 Use [▲] or [▼] to move the cursor to “ON”, and then press the [Confirmation] key. The Auto Print function will turn ON, and printing will be performed every time measurement is performed. After the settings have been configured, the display will return to the <Communication setup> screen.

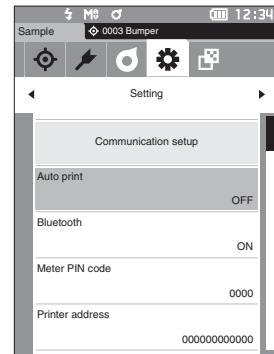

Print Example 1

Display type set to “Spectral Graph”



```
S/N xxxxxxxx
SAMPLE0004
[No Name]
2016/07/21 11:56:14

360nm 44.45
370nm 51.21
:
740nm 20.23
```

Print Example 2

Display type set to “Diff. Graph”

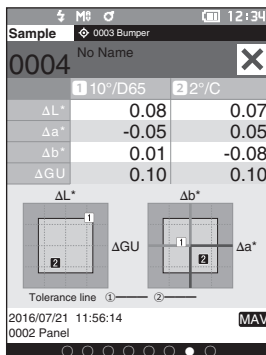

```
S/N xxxxxxxx
SAMPLE0004
[No Name]
2016/07/21 11:56:14
T0001 FAIL
10/D65 2/C
dL* 0.08 0.07
da* -0.05 0.05
db* 0.01 -0.08
dGU 0.10
```

Memo If the color difference result is “Fail”, an “x” will be printed after the value.

Print Example 3

Display type set to "Abs. & Diff."

	1 10°/D65	2 2°/C
L*	99.07	99.03
a*	-0.09	-0.05
b*	0.03	0.01
ΔL^*	0.08	0.07
Δa^*	-0.05	0.05
Δb^*	0.01	-0.08
ΔE^*_{ab}	0.09	0.12
GU	94.26	94.26
ΔGU	0.10	0.10
MI	0.13	0.13

2016/07/21 11:56:14 MAV
0002 Panel

```
S/N xxxxxxxx  
SAMPLE0004  
[No Name]  
2016/07/21 11:56:14  
T0002 FAIL  
10/D65 2/C  
L* 99.07 99.03  
a* -0.09 -0.05  
b* 0.03 0.01  
dL* 0.08 0.07  
da* -0.05 0.05  
db* 0.01 -0.08  
dE* 0.09 0.12x  
GU 94.26  
dGU 0.10  
MI 0.13
```

System Settings

This section explains how to configure calibration, how to display the instrument diagnosis info., and how to display the instrument info.

Operating Procedure

Start the procedure from the measurement screen.

- 1 Press [MENU], and then use [◀] or [▶] to display the <Setting> screen.

Memo To return to the previous screen, press [MENU] or [ESC].

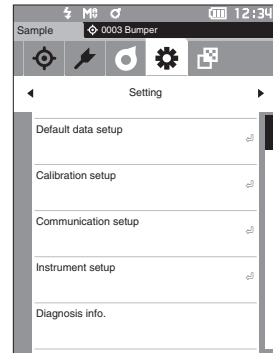

Calibration Setup

Configure the instrument calibration settings.

Operating Procedure

Start the procedure from the <Setting> screen.

- 1 Use [▲] or [▼] to move the cursor to "Calibration setup", and then press the [Confirmation] key.

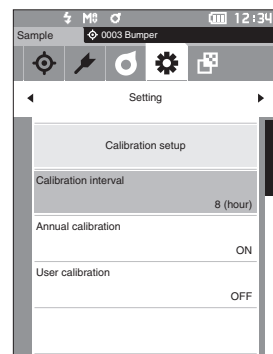
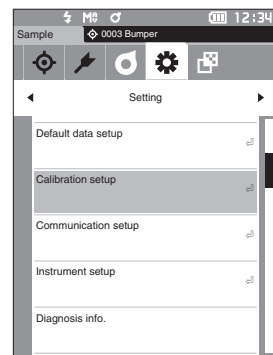

□ Calibration Interval Messages

If the instrument has not been used for an extended period of time since the previous measurement, a message prompting white calibration will appear after start-up and before measurement. The time interval between the previous calibration and when the message is displayed can be configured.

Memo The interval until the calibration is displayed is set to “8 (hour)” when the instrument is shipped from the factory.

Operating Procedure

Start the procedure from the <Calibration setup> screen.

- 1 Use [▲] or [▼] to move the cursor to “Calibration interval”, and then press the [Confirmation] key.

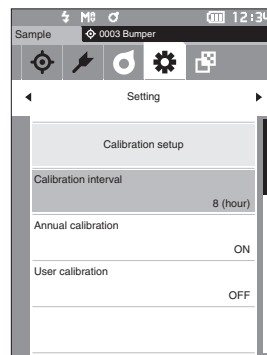

- 2 ▲ and ▼ will be displayed above and below the numbers representing the time until the message is displayed. Use [▲] or [▼] to specify a value.

Settings

- 1 to 24 h: Set the time interval between the previous calibration and when the message should be displayed to between 1 and 24 hours.

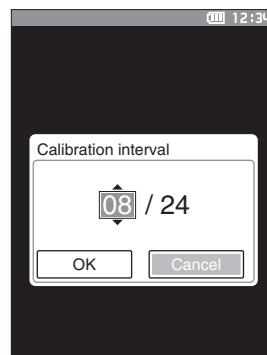

- 3 Press the [Confirmation] key.

The selection is confirmed and the screen returns to the <Calibration setup> screen.

Notes If [ESC] is pressed without pressing the [Confirmation] key, the settings will not be changed and the screen will return to the <Calibration setup> screen.

□ Annual Calibration Messages

As the time for periodic calibration approaches, the instrument shows a message reading “Regularly scheduled device calibration is required. Please contact the nearest service center.” at start-up to recommend annual service recalibration.

The annual calibration message can be set to be shown or to be hidden when the recommended recalibration time comes.

Notes Although the annual calibration message can be hidden, it is recommended to accept our recalibration service.

Memo Display of the annual calibration message is set to “ON (Display)” when the instrument is shipped from the factory.

Operating Procedure

Start the procedure from the <Setting> - <Calibration setup> screen.

1 Press [MENU].

The <Annual calibration> screen is displayed.

Settings

- OFF : Do not show the annual calibration message even if the next calibration date has been passed.
- ON : Show the annual calibration message when the next calibration date approaches.

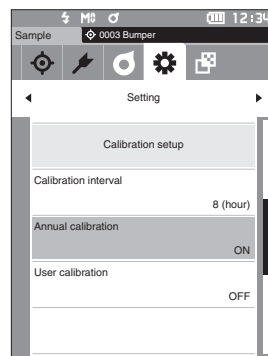

2 Use [◀] or [▶] to move the cursor to select “OFF” or “ON”.

Memo If the annual calibration notification message is set to ON, the annual calibration message will be displayed when the specified day approaches. The date of the next calibration is specified upon initial startup or during KONICA MINOLTA calibration service (or maintenance) and cannot be changed.

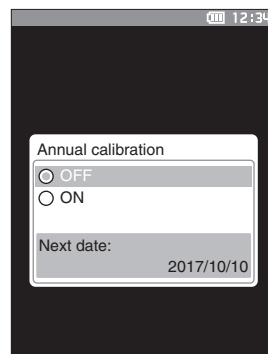

3 Press the [Confirmation] key.

The selection is confirmed and the screen returns to the <Setting> screen.

Notes If [ESC] is pressed without pressing the [Confirmation] key, the settings will not be changed and the screen will return to the <Setting> screen.

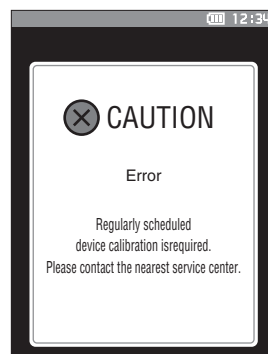

□ User Calibration

You can perform calibration by using your own reference plate and calibration data instead of white calibration. The calibration data for user calibration can be specified by connecting the instrument to a PC and using the optional Color Data Software "SpectraMagic DX". Users can select whether to use the user calibration data for measurement.

Operating Procedure

Start the procedure from <Setting> - <Calibration setup>.

1 Press [MENU].

The <User calibration> screen is displayed.

Settings

- OFF : User calibration cannot be performed.
- ON : User calibration can be performed.

2 Use [◀] or [▶] to move the cursor to select "OFF" or "ON".

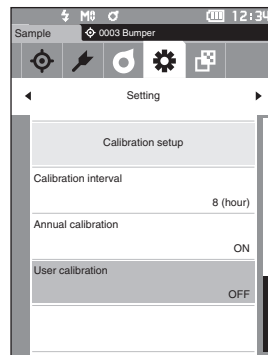

3 Press the [Confirmation] key.

The selection is confirmed and the screen returns to the <Calibration setup> screen.

Notes If [ESC] is pressed without pressing the [Confirmation] key, the settings will not be changed and the screen will return to the <Calibration setup> screen.

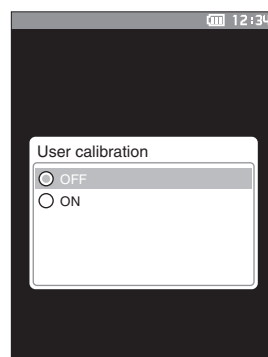

■ Displaying Diagnosis Information

The results of the instrument status diagnosis using the optional “SpectraMagic DX” are displayed. For details, refer to the instruction manual of SpectraMagic DX.

Operating Procedure

Start the procedure from the <Setting> screen.

- 1 Use [▲] or [▼] to move the cursor to “Diagnosis info.”, and then press the [Confirmation] key.

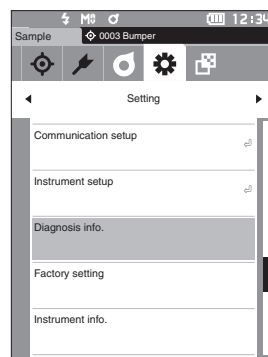

- 2 The instrument status is diagnosed and the results are displayed.

Display

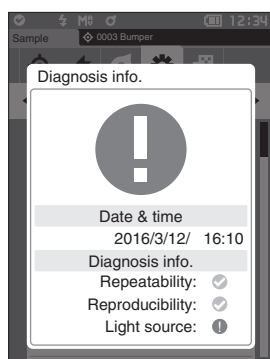

- 3 Press [ESC].
The display will return to the <Setting> screen.

■ Displaying the Instrument Information

Display the product name, version, and serial number of the instrument.

Operating Procedure

Start the procedure from the <Setting> screen.

- 1 Use [▲] or [▼] to move the cursor to “Instrument info.,” and then press the [Confirmation] key.

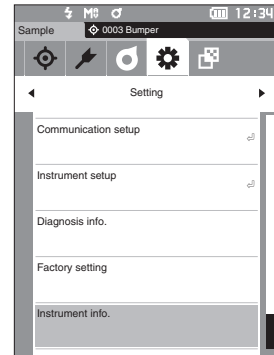

- 2 The instrument information is displayed.

Display Items

- Product name: Instrument product name
- Version: Instrument firmware version
- Serial No.: Instrument serial No.

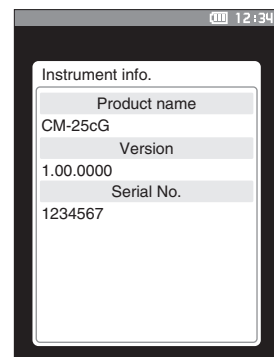

- 3 Press [ESC].

The display will return to the <Setting> screen.

JOB Function

Administrators can pre-register to the instrument workflows to be performed by the worker, allowing the worker to perform measurement according to the registered workflow. This selection screen is available when the job has been set in advance with the optional Color Management Software SpectraMagic NX.

- Notes**
- **Communication via USB is recommended when configuring JOB settings using the optional Color Management Software SpectraMagic NX. Configuration of the JOB function is possible via Bluetooth communication, but transferring settings and images between the computer and the measuring instrument will take time.**
 - **Exiting JOB mode will cause the observation conditions under JOB settings to be reset and the main unit's observation conditions to be restored. As such, if the JOB setting observation conditions differ from the main unit observation conditions, pass/fail results may differ between during JOB execution and after exiting the mode.**

Operating Procedure **Start the procedure from the measurement screen.**

1 Press [MENU], and then use [◀] or [▶] to display the <JOB> screen.

Memo To return to the previous screen, press [MENU] or [ESC].

2 Use [▲] or [▼] to move the cursor to the job to be used.

3 Follow the on-screen instructions to perform measurement.

- Notes**
- **Up to 5 types of jobs can be registered.**
 - **Calibration according to the measurement conditions being used within the job must be performed in advance. Opacity measurement cannot be performed while in JOB mode.**

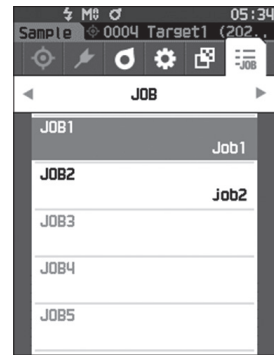

The operations for the various keys on the instrument are as follows.

- [▲] / [▼] key ... Used to switch the data display type (SCI, SCE, or Pass or Fail).
- [◀] / [▶] ... Used to select the Option Item.
- [Confirmation] key... Used to execute the Option Item selected by the cursor.
- [Target/Sample] key ...
 Operation step : Disabled
 Result step : Disabled
- [Menu] ... Disabled
- [ESC] key ... Used to end a job in progress through a warning message. Users can select "YES" or "NO" for the warning. Selecting "YES" will cause the screen to return to the JOB selection screen. Selecting "NO" will maintain the current step.
- [MES] key ...
 Operation step : Performs measurement and moves to the next step.
 Result step : Moves to the next step.

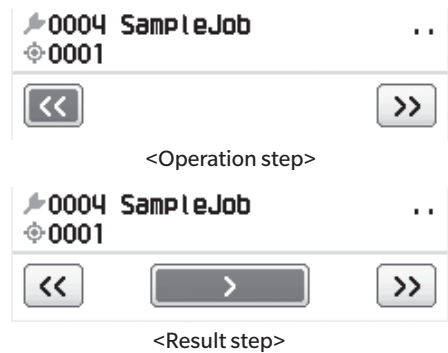

- << ... Moves to the previous step. When returning to the Operation step, the data measured in the Operation step will be discarded, so performing measurement again will be necessary.
- > ... Moves to the next step. This key is not displayed in the Operation step.
- >> ... Moves to the next Operation step.

Chapter 5

Troubleshooting

Message List.....	129
Troubleshooting	131

Message List

Error message: The operation is not correct. Follow the instructions displayed immediately.

ER1_32	There was an error with color measurement device. Restart and try measuring again. If the error occurs again, please contact the nearest service center.
ER1_33	There was an error with the gloss measurement device. Restart and try measuring again. If the error occurs again, please contact the nearest service center.
ER1_34	There is no xenon output. Restart and try measuring again. If the error occurs again, please contact the nearest service center.
ER1_35	There is no LED output. Restart and try measuring again. If the error occurs again, please contact the nearest service center.
ER1_36	The battery status cannot be obtained. Please contact the nearest service center.
ER1_37	There was an error switching diameters. Restart and try measuring again. If the error occurs again, please contact the nearest service center.
ER1_39	There was an error writing to the memory. Restart and try again. If the error occurs again, please contact the nearest service center.
ER1_40	A memory error has occurred. Please contact the nearest service center.
ER1_41	The USB device is not working. Restart the device. If the error occurs again, please contact the nearest service center.
ER1_42	The USB host is not working. Restart the device. If the error occurs again, please contact the nearest service center.
ER1_43	An error has occurred with the clock IC. Please contact the nearest service center.
ER1_47	Connection to the printer failed. Please check the power and the settings.
ER1_51	There was an error with the motor. Restart and try measuring again. If the error occurs again, please contact the nearest service center.
ER1_52	There was an error with the A/D conversion. Restart and try measuring again. If the error occurs again, please contact the nearest service center.

Warning: Continued use will result in incorrect operation. Follow the instructions displayed as soon as possible.

ER1_31	The power supply voltage is insufficient. Please charge.
WR1_1	The power supply voltage is low. Please charge.
WR1_3	Xenon output has dropped. Replacement is recommended.
WR1_4	The LED output has dropped. Replacement is recommended.
WR1_7	The battery is low. Replace the battery.

Caution: The setting or operation is not correct.

ER1_15	The target is protected.	P.63
ER1_18	The data could not be calculated.	
ER1_20	The input data is incorrect.	
ER1_21	No target was found.	
ER1_45	Only administrators can control this function.	P.99
ER1_48	The date is incorrect.	P.102
ER1_49	The set tolerance range is incorrect. Please check the upper and lower limits.	P.66, 75
ER1_53	Check the USB connection.	P.109
WR1_5	The reflectance is outside the range of guaranteed performance.	
WR1_6	The gloss value is outside the range of guaranteed performance.	
WR1_8	Please retry the measurement. Press the measurement button to measure and update to the most recent data.	

Display: The flow of operation is displayed. Perform the operation according to the information displayed.

ER1_1	Regularly scheduled device calibration is required. Please contact the nearest service center.	P.123
ER1_2	Regularly scheduled device calibration is approaching. Please contact the nearest service center.	P.123
ER1_3	Please set the instrument on the zero calibration box and calibrate.	P.32
ER1_4	Perform zero calibration.	P.32
ER1_6	Please set the instrument on the white calibration plate and calibrate.	P.34
ER1_7	Perform white calibration.	P.34
ER1_8	Configure the white calibration data.	P.34
ER1_9	Please set the instrument on the gloss calibration plate and calibrate.	P.35
ER1_10	Perform gloss calibration.	P.35
ER1_11	Configure the gloss calibration data.	P.34
ER1_12	Please set the instrument on the user calibration plate and calibrate.	P.36
ER1_13	Perform user calibration.	P.36
ER1_14	Configure the user calibration data.	P.36
ER1_16	The device memory is full. Please delete some data to measure.	P.38, 47
ER1_17	Specify at least one.	
ER1_38	Please close the viewfinder.	P.37
ER1_50	Calibration is required. Would you like to calibrate now?	P.32
WR1_2	Calibration is recommended. Would you like to calibrate now?	P.32, 122
WR1_9	Data is being saved. Please wait until the power turns off.	
WR1_10	Data is being processed. Please wait.	

Troubleshooting

If an abnormality has occurred with the instrument, take the necessary actions as given in the table below. If the instrument still does not work properly, turn the power OFF and temporarily disconnect the battery. Reinsert the battery and turn the power back ON. If the symptom remains, contact a KONICA MINOLTA-authorized service facility.

Symptom	Check Point	Action
The display on the LCD screen is blank. The backlight does not illuminate.	Has the battery been installed correctly? Is the battery dead?	Install the battery correctly, or use the AC adapter or USB bus power to charge the battery.
	Turn the instrument ON. Is the Auto power off setting configured?	Change the Auto power off setting as required.
Measuring button is not effective.	Is measurement still in progress?	Wait until measurement is complete, and then press the button.
	Is a screen where measurement is possible displayed?	The measurement button must be pressed while a screen that allows measurement (e.g. Calibration, Target, or Sample screen) is shown.
Measurement results are abnormal.	Is the specimen placed properly?	Make sure that the specimen is securely placed in the instrument to prevent leakage of light.
	Is proper calibration data used?	User calibration data is written to the instrument using the optional software. Verify that the calibration plate is correct for the input calibration data before performing white calibration or user calibration.
	Was white calibration or gloss calibration performed correctly?	
	Was zero calibration performed correctly?	Read page 32 "Zero Calibration" and perform zero calibration properly.
	Is the surface of the white calibration plate or gloss calibration plate dirty?	Read page 18 "Cleaning Parts" and clean the parts before performing calibration again.
Measurement results fluctuate.	Is the instrument and specimen kept stationary during measurement?	Do not allow the instrument and specimen to move during measurement. Use averaging measurement as needed.
	Is the specimen in contact with the measuring port?	Take care to ensure the specimen is in contact with measuring port to prevent displacement or tilting from occurring.
Data cannot be input to a PC. No commands from the PC are accepted. Commands cannot be accepted correctly.	Is the USB cable connected correctly?	Connect the instrument's USB connecting terminal to the computer's USB port with the USB cable supplied with the instrument.
	Has Bluetooth communication been established?	Check the Bluetooth module and ensure that it is connected correctly.
Printing is not possible.	Has Bluetooth communication been established?	Check the Bluetooth module and ensure that it is connected correctly.
Measurement data or settings are not held in memory and disappear immediately.	The instrument's backup battery may be low immediately after purchase or following a period of prolonged non-use. Turn the instrument ON to charge the backup battery. Under this condition, the backup battery will be fully charged in 20 hours.	If the instrument fails to retain data in memory even after the battery has been fully charged, however, the battery has likely reached the end of its life and requires replacement. To replace the backup battery, please contact a KONICA MINOLTA-authorized service facility.

Chapter 6

Appendix

Specifications 133
Dimensions 135

Specifications

Model		Spectrophotometer CM-25cG
Color	Illumination/ viewing system	45°c: 0° Conforms to CIE No. 15 (2004), ISO 7724/1, ASTM E179, ASTM E1164, DIN 5033 Teil 7, and JIS Z8722 Condition A
	Detector	Dual 40-element silicon photodiode arrays
	Spectral separation device	Planar diffraction grating
	Wavelength range	360-740 nm
	Wavelength pitch	10 nm
	Half bandwidth	Approx. 10 nm
	Measurement range	0-175%; Output/display resolution: 0.01%
	Light source	Pulsed xenon lamp
	Measurement/ illumination area	MAV: ø8 mm/12×16 mm, SAV: ø3 mm/12×16 mm
	Repeatability	Chromaticity value: Standard deviation within ΔE^*ab 0.04 (When a white calibration plate is measured 30 times at 10-second intervals after white calibration under Konica Minolta standard measurement conditions)
	Inter-instrument agreement	Within ΔE^*ab 0.15 (MAV) (Average for 12 BCRA Series II color tiles compared to values measured with a master body under Konica Minolta standard measurement conditions)
	Observer	2° or 10° Standard Observer
	Illuminant	A, C, D50, D65, F2, F6, F7, F8, F10, F11, F12, ID50, ID65, User illuminant ¹ (simultaneous evaluation with two light sources possible)
	Displayed data	Spectral values/graph, colorimetric values/graph, color-difference values/graph, pass/fail judgement, pseudocolor
	Colorimetric data	L*a*b*, L*C*h, Hunter Lab, Yxy, XYZ, and color differences in these spaces; Munsell
	Indexes	MI, WI (ASTM E313-73), YI (ASTM E313-73, ASTM D1925), ISO brightness (ISO2470), WI/Tint (CIE), User index ¹
Color-difference equation	ΔE^*ab (CIE1976), ΔE^*94 (CIE1994), ΔE_{00} (CIEDE2000), CMC (l:c), ΔE (Hunter), ΔE_{99o} (DIN99o)	
Gloss	Measurement geometry	60°
	Light source	LED
	Detector	Silicon photo diode
	Color sensitivity	Spectrally adjusted to CIE photopic luminous efficiency $V(\lambda)$ under CIE illuminant C
	Measurement range	0-200 GU; Output/display resolution: 0.01 GU
	Measurement area	MAV: ø10 mm, SAV: ø3 mm
	Repeatability	Standard deviation 0-10 GU: Within 0.1 GU 10-100 GU: Within 0.2 GU >100 GU: Within 0.2% of displayed value (When measured 30 times at 10-second intervals under measurement conditions specified by KONICA MINOLTA)
	Inter-instrument agreement	0-10 GU: Within ± 0.2 GU 10-100 GU: Within ± 0.5 GU (MAV. Compared to values measured with a master body under KONICA MINOLTA standard conditions)
	Standard compliance	JIS Z8741 (MAV), JIS K5600, ISO 2813, ISO 7668 (MAV), ASTM D523-08, ASTM D2457-13, DIN 67530

Measurement time	Approx. 1 second (Time between pressing the measurement button and measurement completes)
Minimum measurement interval	Approx. 2 seconds
Battery performance	Approx. 3,000 measurements (Measurement at 10-second intervals at 23°C with the dedicated lithium-ion battery fully charged) Approx. 1,000 measurements when using Bluetooth
Displayed languages	Japanese, English, German, French, Italian, Spanish, Chinese (Simplified), Portuguese, Russian, Turkish, Polish
Display	2.7-inch TFT color LCD
Interfaces	USB 2.0; Bluetooth (SPP compatible. Using optional Bluetooth Module)
Data memory	Target data: 2,500 measurements; Sample data: 7,500 measurements
Power	Dedicated lithium-ion battery (removable), USB bus power (with lithium-ion battery installed), Dedicated AC adapter (with lithium-ion battery installed)
Charging time	Approx. 6 hours when no charge remains
Operation temperature/humidity range	5-40°C, relative humidity is 80% or less (at 35°C) with no condensation
Storage temperature/humidity range	0-45°C, relative humidity is 80% or less (at 35°C) with no condensation
Size (W×H×D)	81×81×224 mm
Weight	Approx. 600 g (Including battery)

*1 Optional Color Management Software SpectraMagic NX (Ver. 2.8 or later) is required for setting user-configured illuminants or user indexes.

Dimensions

(Unit: mm)

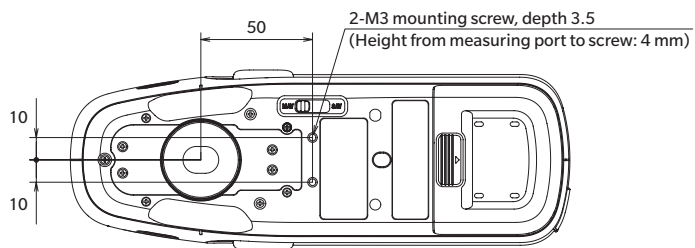
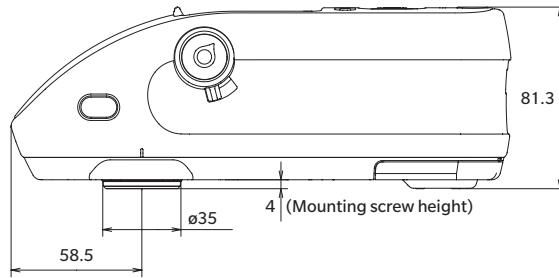
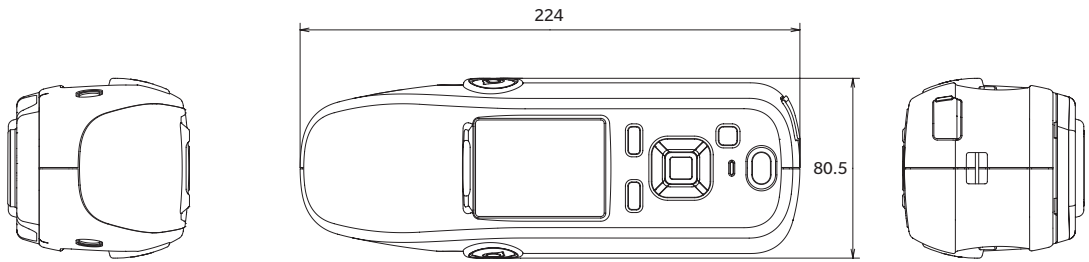

< CAUTION >

KONICA MINOLTA WILL NOT BE LIABLE FOR ANY DAMAGES RESULTING FROM THE MISUSE, MISHANDLING, UNAUTHORIZED MODIFICATION, ETC. OF THIS PRODUCT, OR FOR ANY INDIRECT OR INCIDENTAL DAMAGES (INCLUDING BUT NOT LIMITED TO LOSS OF BUSINESS PROFITS, INTERRUPTION OF BUSINESS, ETC.) DUE TO THE USE OF OR INABILITY TO USE THIS PRODUCT.

User Equation and User Class

- The User Equation (User Index) function allows users to input an equation defined by the user and using values currently set for display on the instrument, and have the instrument show the results of the user-defined equation.
- The User Class function allows users to classify measurements into groups (such as grades or ranks) according to the results of a defined User Equation.

Registering a User Equation and/or User Class on the instrument

The User Equation and/or User Class can be registered on the instrument using Color Data Software SpectraMagic NX.

- The User Class is defined based on the User Equation of the same number. For example, UC1 is defined based on UE1. If no User Equation is defined for the selected UC number, the User Class definition will not be used.

Displaying the results of a User Equation and/or User Class on the instrument

The calculated results for a User Equation and/or User Class can be displayed by selecting UE1 to UE3 (User Equation 1 to 3) and/or UC1 to UC3 (User Class 1 to 3) in a Custom screen of Display cond. on the instrument. (See Display Settings in the Instruction Manual for the instrument.)

Measurement values

The following measurement values can be used in User Equation.

- The measurement values to be used in the User Equation and **to be displayed on Custom screen** must be set to be displayed on the instrument in the Display type, Color space, Equation, or Custom screen of Display cond. on the instrument. (See Display Settings in the Instruction Manual for the instrument.)
- Measurement values not listed in the table below cannot be used.

L*	a*	b*	C*	h
L(Hunter)	a(Hunter)	b(Hunter)	X	Y
Z	x	y	GU	ΔL^*
Δa^*	Δb^*	ΔC^*	ΔH^*	$\Delta L(\text{Hunter})$
$\Delta a(\text{Hunter})$	$\Delta b(\text{Hunter})$	ΔX	ΔY	ΔZ
Δx	Δy	ΔGU	ΔE^*ab	CMC
ΔE^*94	$\Delta E00$	$\Delta E(\text{Hunter})$	MI	WI(E313-73)
$\Delta WI(\text{E313-73})$	WI(CIE)	$\Delta WI(\text{CIE})$	Tint(CIE)	$\Delta Tint(\text{CIE})$
YI(E313-73)	$\Delta YI(\text{E313-73})$	YI(D1925)	$\Delta YI(\text{D1925})$	B(ISO)
$\Delta B(\text{ISO})$				

Refer to **Input Format** below.

Functions

The following functions can be used in User Equation.

Mathematical functions	Trigonometric functions	Other functions
addition, subtraction, multiplication, division	sin, cos, tan, \sin^{-1} , \cos^{-1} , \tan^{-1}	square, square root, absolute value, logarithm, natural logarithm, exponent, power

Refer to **Input Format** below.

User Equation

Input example

To input the equation for ΔE^*ab

$$\Delta E^* ab = \sqrt{(\Delta L^*)^2 + (\Delta a^*)^2 + (\Delta b^*)^2}$$

as a User Equation, it would be:

SQRT(POW([DL])+POW([DA])+POW([DB]))

Input Format

A User Equation is defined using numbers and strings for measurement value variables and functions.

- Parameter strings are explained in **Input Format** below.
- The total length of a User Equation definition including numbers and string parameters is 200 characters.

Numerical constants

Numbers can be input as constants using 0 to 9 and the decimal point.

Although there is no limit on the number of decimal places that can be input, the number of significant digits for calculations is 5 places.

Measurement value variables

For CM-25cG

Variable	Measurement value	Variable	Measurement value	Variable	Measurement value
[L]	L*	[A]	a*	[B]	b*
[DL]	ΔL^*	[DA]	Δa^*	[DB]	Δb^*
[C]	C*	[H]	H		
[DC]	ΔC^*	[DH]	ΔH^*		
[HL]	L(Hunter)	[HA]	a(Hunter)	[HB]	b(Hunter)
[DHL]	ΔL (Hunter)	[DHA]	Δa (Hunter)	[DHB]	Δb (Hunter)
[X]	X	[Y]	Y	[Z]	Z
[DX]	ΔX	[DY]	ΔY	[DZ]	ΔZ
[SX]	x	[SY]	y		
[DSX]	Δx	[DSY]	Δy		
[GU]	GU	[DGU]	ΔGU		
[DE]	ΔE^*ab	[CMC]	CMC	[DE94]	ΔE^*94
[DE00]	$\Delta E00$	[DEH]	ΔE (Hunter)	[MI]	MI
[WIE]	WI E313-73	[WIC]	WI CIE	[TINT]	Tint CIE
[DEWI]	ΔWI E313-73	[DWIC]	ΔWI CIE	[DTINT]	$\Delta Tint$ CIE
[YIE]	YI E313-73	[YID]	YI D1925	[BISO]	B(ISO)
[DYIE]	ΔYI E313-73	[DYID]	ΔYI D1925	[DBISO]	ΔB (ISO)

For CM-26dG, CM-26d, CM-25d

Common variables

- Calculations will be performed using the SCI/SCE setting of the current screen. In the SCI screen, SCI values will be used and in the SCE screen, SCE values will be used.

Variable	Measurement value	Variable	Measurement value	Variable	Measurement value
[L]	L*	[A]	a*	[B]	b*
[DL]	ΔL^*	[DA]	Δa^*	[DB]	Δb^*
[C]	C*	[H]	H		
[DC]	ΔC^*	[DH]	ΔH^*		
[HL]	L(Hunter)	[HA]	a(Hunter)	[HB]	b(Hunter)
[DHL]	ΔL (Hunter)	[DHA]	Δa (Hunter)	[DHB]	Δb (Hunter)
[X]	X	[Y]	Y	[Z]	Z
[DX]	ΔX	[DY]	ΔY	[DZ]	ΔZ
[SX]	x	[SY]	y		
[DSX]	Δx	[DSY]	Δy		
[GU]	GU	[DGU]	ΔGU		
[DE]	ΔE^*ab	[CMC]	CMC	[DE94]	ΔE^*94
[DE00]	$\Delta E00$	[DEH]	ΔE (Hunter)	[MI]	MI
[WIE]	WI E313-73	[WIC]	WI CIE	[TINT]	Tint CIE
[DEWI]	ΔWI E313-73	[DWIC]	ΔWI CIE	[DTINT]	$\Delta Tint$ CIE
[YIE]	YI E313-73	[YID]	YI D1925	[BISO]	B(ISO)
[DYIE]	ΔYI E313-73	[DYID]	ΔYI D1925	[DBISO]	ΔB (ISO)

- GU and ΔGU can be used only with CM-26dG. UVfull+UVcut is available only with CM-26dG and 26d devices.

SCI variables

SCI values will be used even if the SCE screen is selected.

- Instrument Specular Component setting must include SCI.

Variable	Measurement value	Variable	Measurement value	Variable	Measurement value
[LI]	L*	[AI]	a*	[BI]	b*
[DLI]	ΔL^*	[DAI]	Δa^*	[DBI]	Δb^*
[CI]	C*	[HI]	H		
[DCI]	ΔC^*	[DHI]	ΔH^*		
[HLI]	L(Hunter)	[HAI]	a(Hunter)	[HBI]	b(Hunter)
[DHLI]	ΔL (Hunter)	[DHAI]	Δa (Hunter)	[DHBI]	Δb (Hunter)
[XI]	X	[YI]	Y	[ZI]	Z
[DXI]	ΔX	[DYI]	ΔY	[DZI]	ΔZ
[SXI]	x	[SYI]	y		
[DSXI]	Δx	[DSYI]	Δy		
[GUI]	GU	[DGUI]	ΔGU		
[DEI]	ΔE^*_{ab}	[CMCI]	CMC	[DE94I]	ΔE^*_{94}
[DE00I]	ΔE_{00}	[DEHI]	ΔE (Hunter)	[MII]	MI
[WIEI]	WI E313-73	[WICI]	WI CIE	[TINTI]	Tint CIE
[DEWII]	ΔWI E313-73	[DWICI]	ΔWI CIE	[DTINTI]	$\Delta Tint$ CIE
[YIEI]	YI E313-73	[YIDI]	YI D1925	[BISOI]	B(ISO)
[DYIEI]	ΔYI E313-73	[DYIDI]	ΔYI D1925	[DBISOI]	ΔB (ISO)

SCE variables

SCE values will be used even if the SCI screen is selected.

- instrument Specular Component setting must include SCE.

Variable	Measurement value	Variable	Measurement value	Variable	Measurement value
[LE]	L*	[AE]	a*	[BE]	b*
[DLE]	ΔL^*	[DAE]	Δa^*	[DBE]	Δb^*
[CE]	C*	[HE]	H		
[DCE]	ΔC^*	[DHE]	ΔH^*		
[HLE]	L(Hunter)	[HAE]	a(Hunter)	[HBE]	b(Hunter)
[DHLE]	ΔL (Hunter)	[DHAE]	Δa (Hunter)	[DHBE]	Δb (Hunter)
[XE]	X	[YE]	Y	[ZE]	Z
[DXE]	ΔX	[DYE]	ΔY	[DZE]	ΔZ
[SXE]	x	[SYE]	y		
[DSXE]	Δx	[DSYE]	Δy		
[GUE]	GU	[DGUE]	ΔGU		
[DEE]	ΔE^*ab	[CMCE]	CMC	[DE94E]	ΔE^*94
[DE00E]	$\Delta E00$	[DEHE]	ΔE (Hunter)	[MIE]	MI
[WIEE]	WI E313-73	[WICE]	WI CIE	[TINTE]	Tint CIE
[DEWIE]	ΔWI E313-73	[DWICE]	ΔWI CIE	[DTINTE]	$\Delta Tint$ CIE
[YIEE]	YI E313-73	[YIDE]	YI D1925	[BISOE]	B(ISO)
[DYIEE]	ΔYI E313-73	[DYIDE]	ΔYI D1925	[DBISOE]	ΔB (ISO)

UVfull+UVcut simultaneous measurement data

UVfull * UVfull values will also be used on the UVcut screen.

Variable	Measurement value	Variable	Measurement value	Variable	Measurement value
[LF]	L*	[AF]	a*	[BF]	b*
[DLF]	ΔL^*	[DAF]	Δa^*	[DBF]	Δb^*
[CF]	C*	[HF]	h		
[DCF]	ΔC^*	[DHF]	ΔH^*		
[HLF]	L(Hunter)	[HAF]	a(Hunter)	[HBF]	b(Hunter)
[DHLF]	ΔL (Hunter)	[DHAF]	Δa (Hunter)	[DHBF]	Δb (Hunter)
[XF]	X	[YF]	Y	[ZF]	Z
[DXF]	ΔX	[DYF]	ΔY	[DZF]	ΔZ
[SXF]	x	[SYF]	y		
[DSXF]	Δx	[DSYF]	Δy		
[DEF]	ΔE^*ab	[CMCF]	CMC	[DE94F]	ΔE^*94
[DE00F]	$\Delta E00$	[DEHF]	ΔE (Hunter)	[MIF]	MI
[WIEF]	WI E313-73	[WICF]	WI CIE	[TINTF]	Tint CIE
[DEWIF]	ΔWI E313-73	[DWICF]	ΔWI CIE	[DTINTF]	$\Delta Tint$ CIE
[YIEF]	YI E313-73	[YIDF]	YI D1925	[BISOF]	B(ISO)
[DYIEF]	ΔYI E313-73	[DYIDF]	ΔYI D1925	[DBISOF]	ΔB (ISO)

UVcut * UVcut values will also be used on the UVfull screen.

Variable	Measurement value	Variable	Measurement value	Variable	Measurement value
[LC]	L*	[AC]	a*	[BC]	b*
[DLC]	ΔL^*	[DAC]	Δa^*	[DBC]	Δb^*
[CC]	C*	[HC]	h		
[DCC]	ΔC^*	[DHC]	ΔH^*		
[HLC]	L(Hunter)	[HAC]	a(Hunter)	[HBC]	b(Hunter)
[DHLC]	ΔL (Hunter)	[DHAC]	Δa (Hunter)	[DHBC]	Δb (Hunter)
[XC]	X	[YC]	Y	[ZC]	Z
[DXC]	ΔX	[DYC]	ΔY	[DZC]	ΔZ
[SXC]	x	[SYC]	y		
[DSXC]	Δx	[DSYC]	Δy		
[DEC]	ΔE^*ab	[CMCC]	CMC	[DE94C]	ΔE^*94
[DE00C]	$\Delta E00$	[DEHC]	ΔE (Hunter)	[MIC]	MI
[WIEC]	WI E313-73	[WICC]	WI CIE	[TINTC]	Tint CIE
[DEWIC]	ΔWI E313-73	[DWICC]	ΔWI CIE	[DTINTC]	$\Delta Tint$ CIE
[YIEC]	YI E313-73	[YIDC]	YI D1925	[BISOC]	B(ISO)
[DYIEC]	ΔYI E313-73	[DYIDC]	ΔYI D1925	[DBISOC]	ΔB (ISO)

Example of User Equation results when using common, SCI only, and SCE only variables in SCI and SCE screens

	SCI screen	SCE screen
[L]	100	50
[L]+[LI]+[LE]	250 (= 100+100+50)	200 (=50+100+50)

Example of UVfull+UVcut simultaneous measurement data display results

	UV100	UV0
[L]	100	50
[L]+[LF]+[LC]	250 (= 100+100+50)	200 (=50+100+50)

Functions

Function string	Usage example	Explanation
+	A+B	= A + B
-	A-B	= A - B
*	A*B	= A × B
/	A/B	= A/B
POW	POW(A)	= A ²
SQRT	SQRT(A)	= \sqrt{A}
ABS	ABS(A)	= A (Absolute value of A)
SIN	SIN(A)	= sin A (where A is in degrees)
COS	COS(A)	= cos A (where A is in degrees)
TAN	TAN(A)	= tan A (where A is in degrees)
ASIN	ASIN(A)	= sin ⁻¹ A (where A is in degrees)
ACOS	ACOS(A)	= cos ⁻¹ A (where A is in degrees)
ATAN	ATAN(A)	= tan ⁻¹ A (where A is in degrees)
LOG	LOG(A)	= log A
LN	LN(A)	= ln A
EXP	EXP(A)	= e ^A
POW2	POW2(A,B)	= A ^B

User Class

The User Class classifies measurements according to the results of the User Equation having the same number (for example, UC1 classifies measurements according to the results of UE1).

Input Example

To classify measurements into 5 classes A, B, C, D, E based on the following conditions:

User Equation result	Class
$UE \geq 4$	A
$UE \geq 3$	B
$UE \geq 2$	C
$UE \geq 1$	D
$UE < 1$	E

the class definition would be:

CLASS(4, "A", 4, "B", 3, "C", 2, "D", 1, "E")

Input Format

CLASS(*n*, "*str1*", *d1*, "*str2*", *d2*, "*str3*", *d3*, ...)

where

<i>n</i>	Number of class thresholds (= number of classes - 1)
<i>str1</i>	Class label for class threshold 1. This label will be applied to UE values greater than class threshold 1.
<i>d1</i>	Class threshold 1
<i>str2</i>	Class label for class threshold 2. This label will be applied to UE values greater than class threshold 2 but less than class threshold 1.
<i>d2</i>	Class threshold 2
<i>str3</i>	Class label for class threshold 3. This label will be applied to UE values greater than class threshold 3 but less than class threshold 2.
<i>d3</i>	Class threshold 3
:	
:	

- *n* maximum value: 50
- Class label *str* maximum length: 6 characters
- Usable characters for class labels *str* are shown in the table on the following page.
- Class threshold *d* maximum length: 20 characters, but the number of significant digits used for calculations is 5.
- Classes should be input in order from classes with the largest threshold to the smallest threshold.
- Overall maximum length including "CLASS()": 200 characters
- If User Class will not be used, do not input a User Class definition.
- Class definition parameters are separated by commas ",".
- Period "." is used for the decimal point.

Usable characters for class labels

The following characters can be used.

- (sp) indicates a space.

	00	10	20	30	40	50	60	70
0			(sp)	0	@	P	`	p
1			!	1	A	Q	a	q
2			“	2	B	R	b	r
3			#	3	C	S	c	s
4			\$	4	D	T	d	t
5			%	5	E	U	e	u
6			&	6	F	V	f	v
7			'	7	G	W	g	w
8			(8	H	X	h	x
9)	9	I	Y	i	y
A			*	:	J	Z	j	z
B			+	;	K	[k	{
C			,	<	L	¥	l	
D			-	=	M]	m	}
E			.	>	N	^	n	
F			/	?	O	_	o	



KONICA MINOLTA